

**INSTRUKCJA MONTAŻU**  
**ASSEMBLING**  
**INSTRUCTIONS**  
**Aufbauanleitung**

**LIV'IN**  
**FARO 289**



30 min







x1

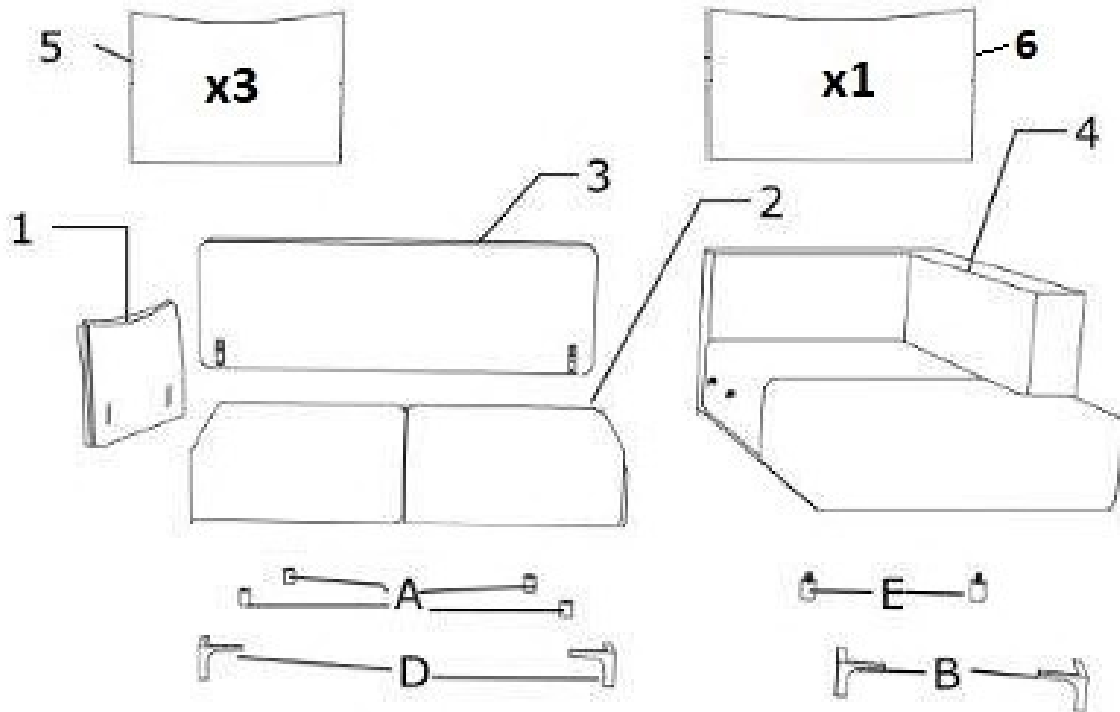
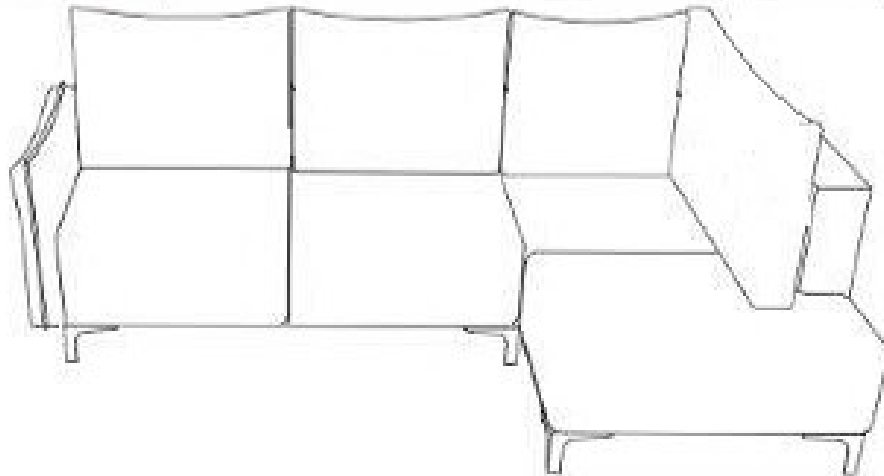

x2

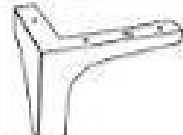

<b>A</b>	x4	<b>B</b>	x2	<b>C</b>	x18	<b>D</b>	x2	<b>E</b>	x2
									



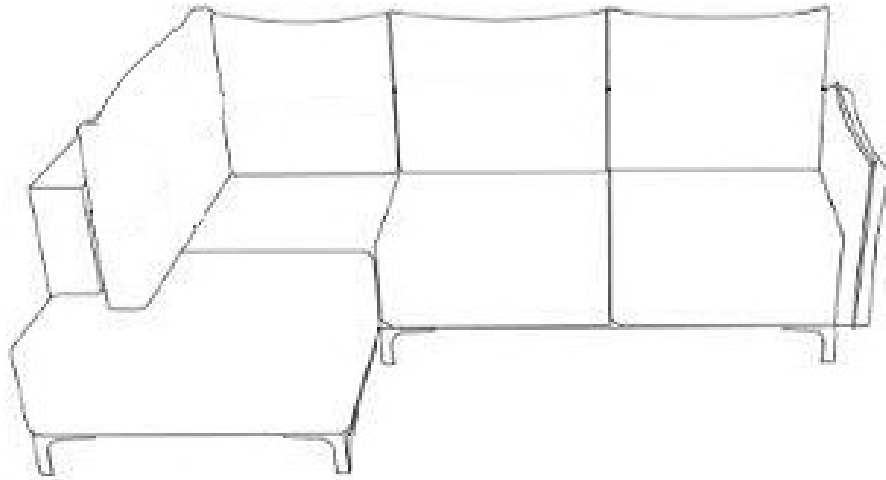

**1**

**L**





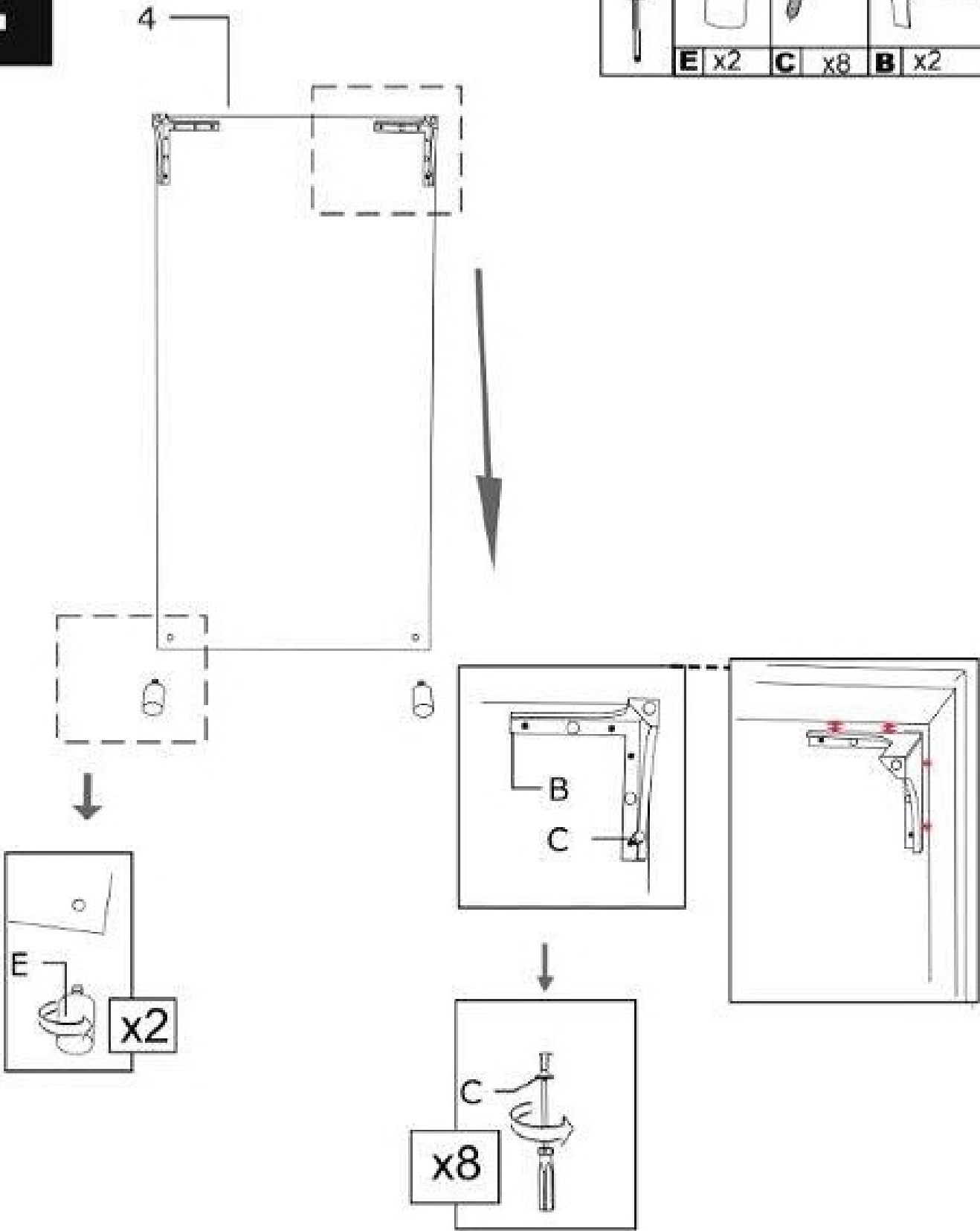

**R**

# 2

			
	<b>E</b> x2	<b>C</b> x8	<b>B</b> x2



# 3

			
<b>A</b>	x4	<b>C</b>	x10
		<b>D</b>	x2

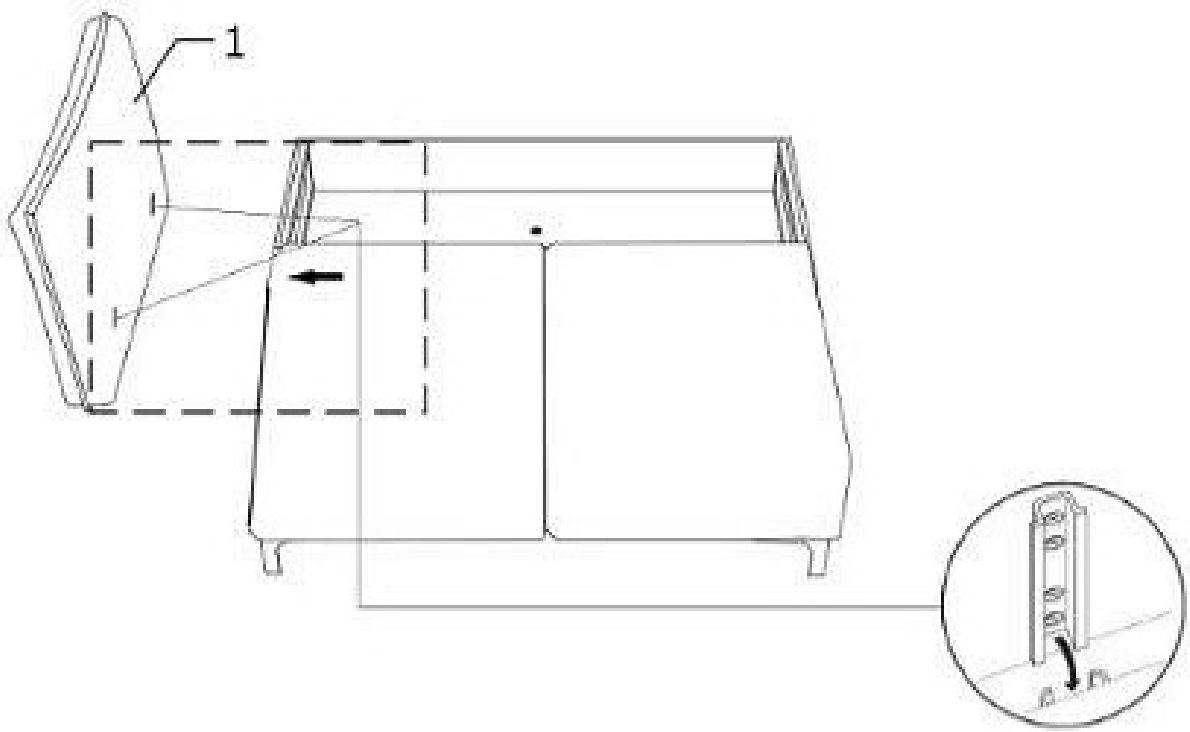
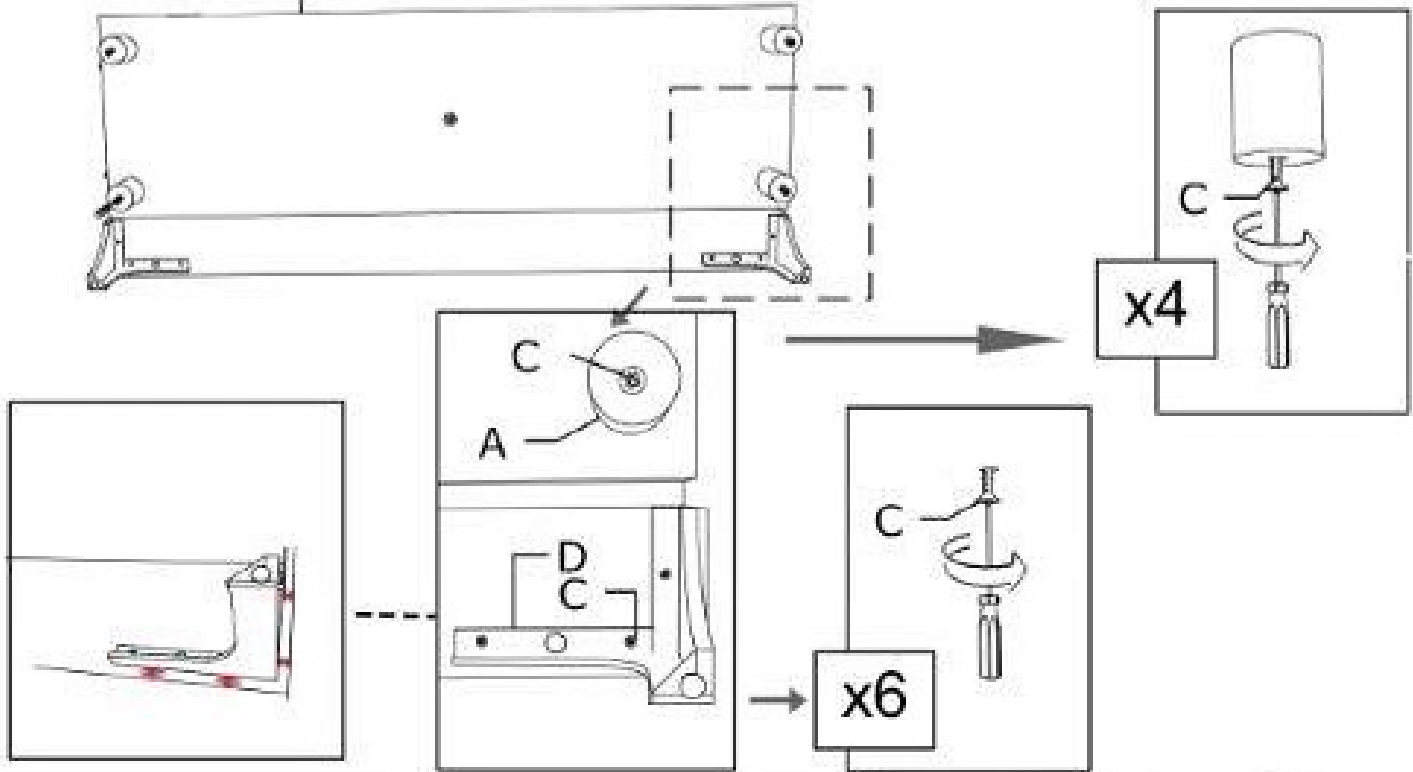

4

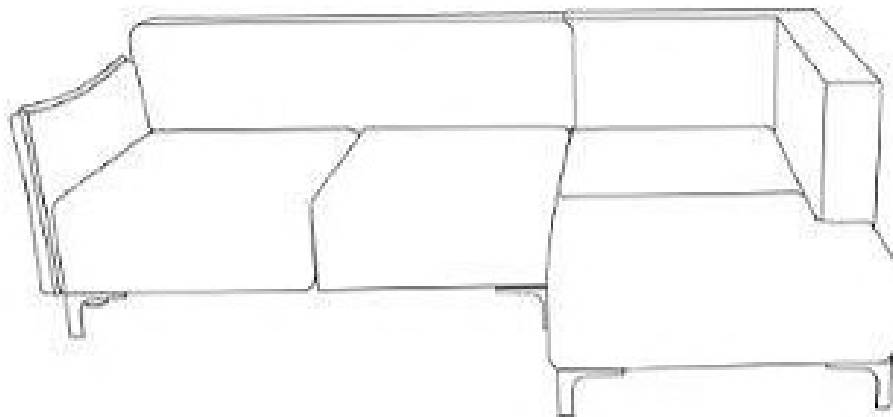
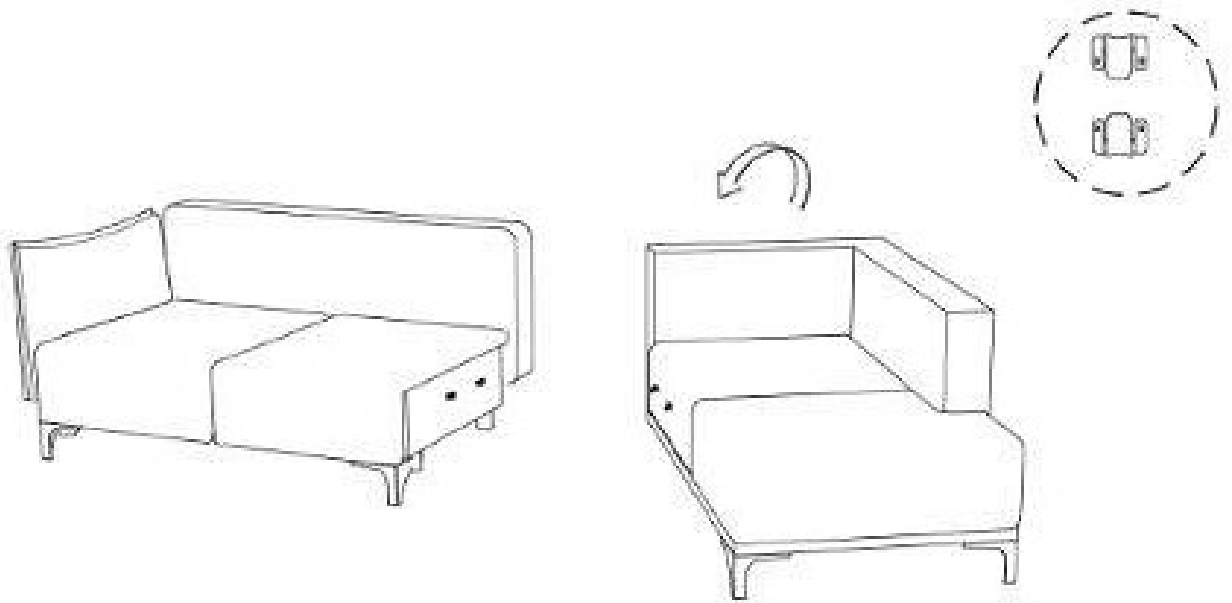
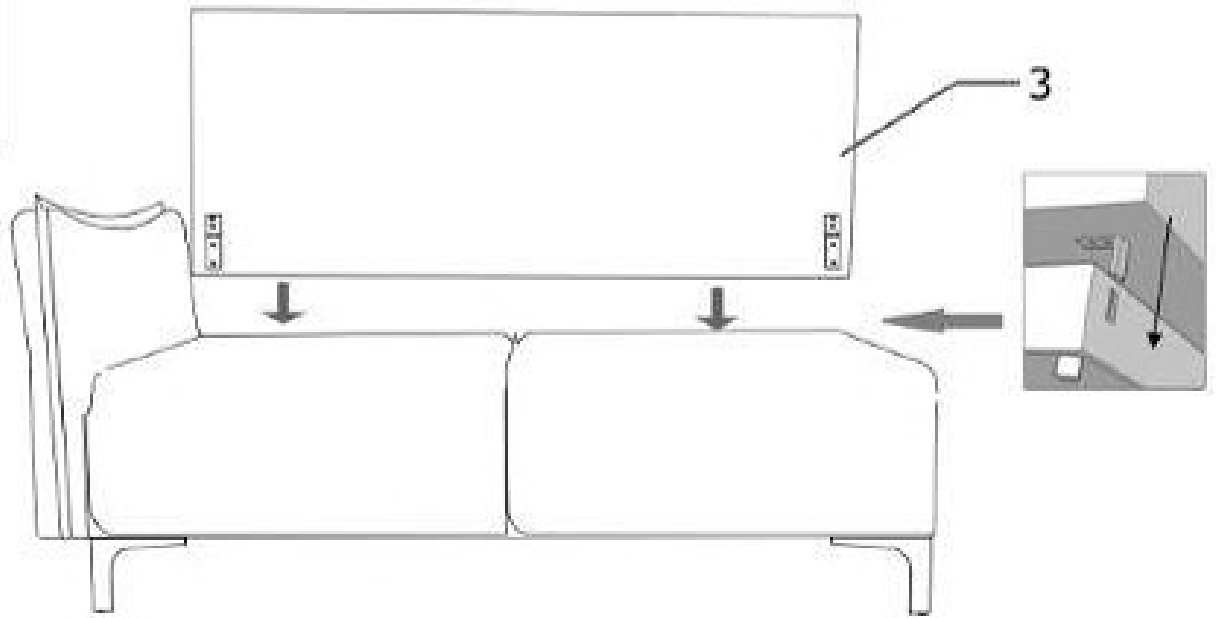

5

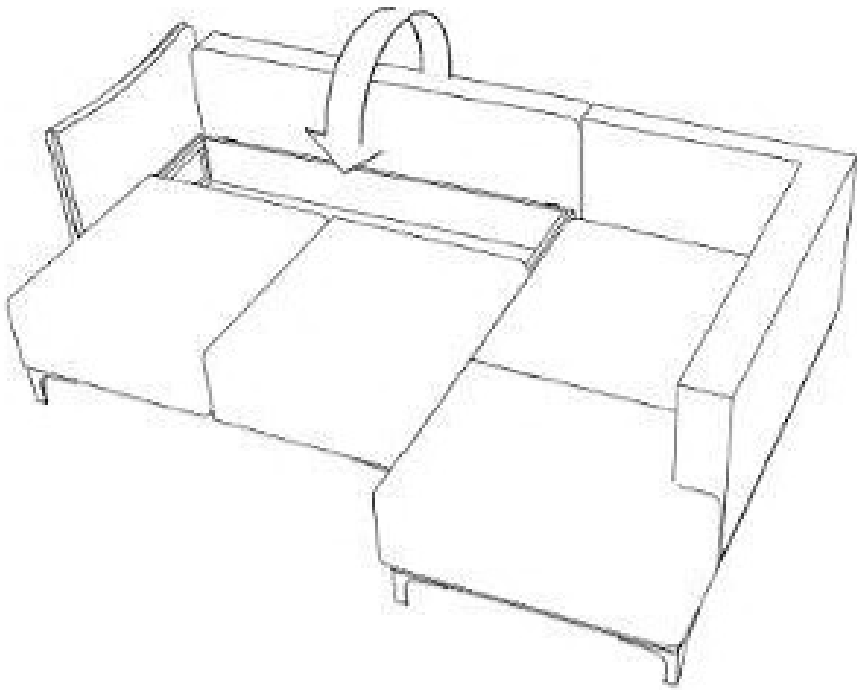
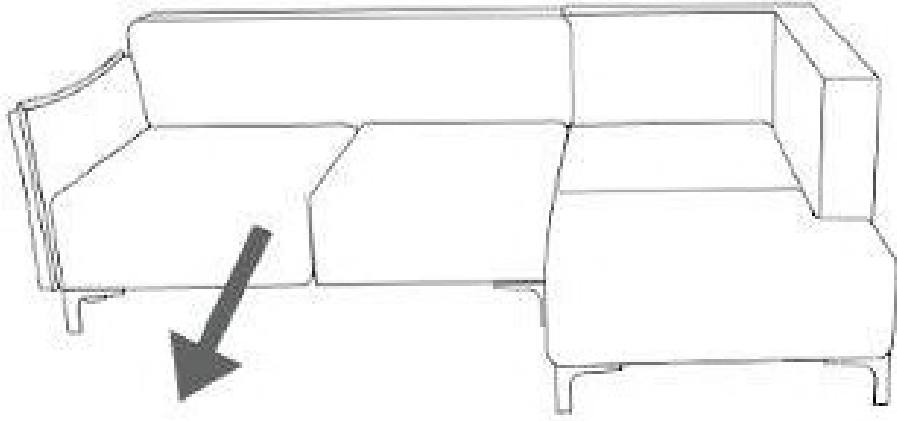

6

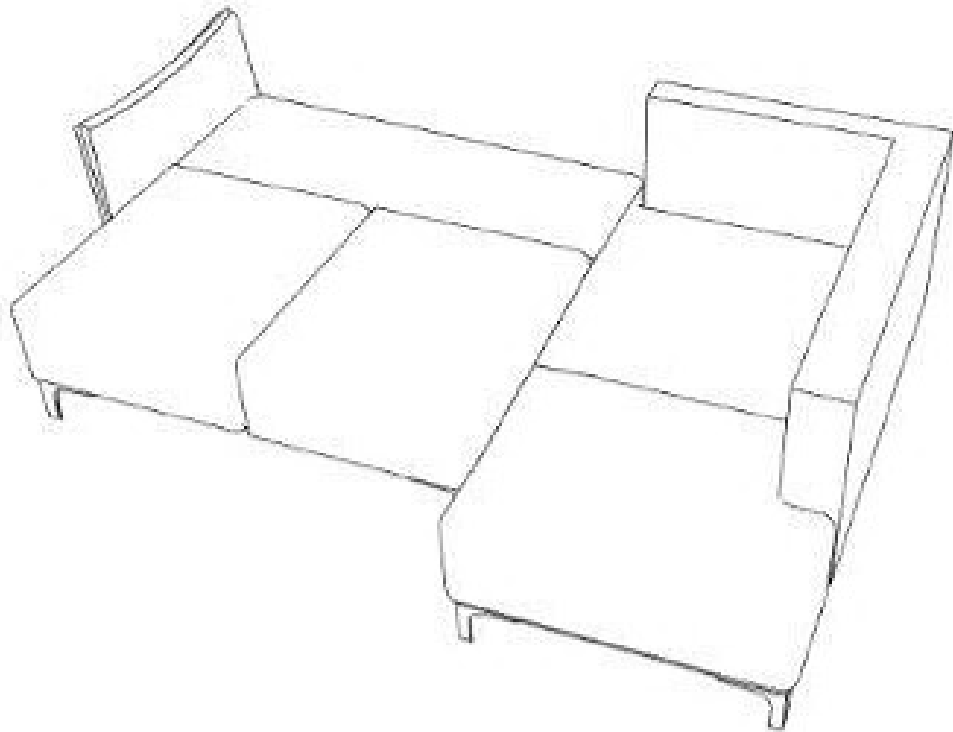
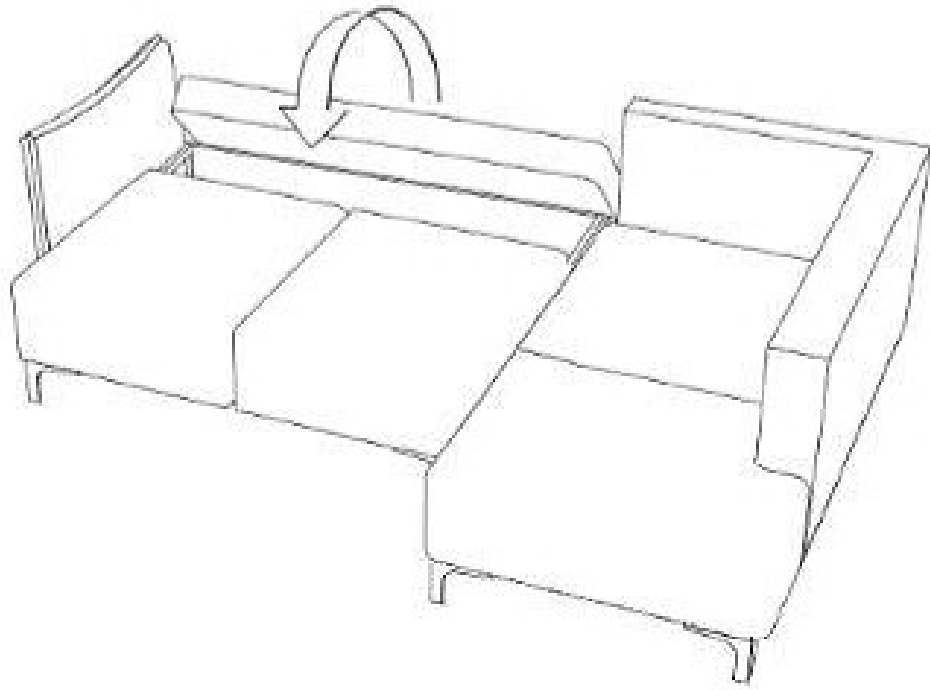

**INSTRUKCJA MONTAŻU**  
**ASSEMBLING**  
**INSTRUCTIONS**  
**Aufbauanleitung**

**LIV'IN**  
**FARO 289**



30 min









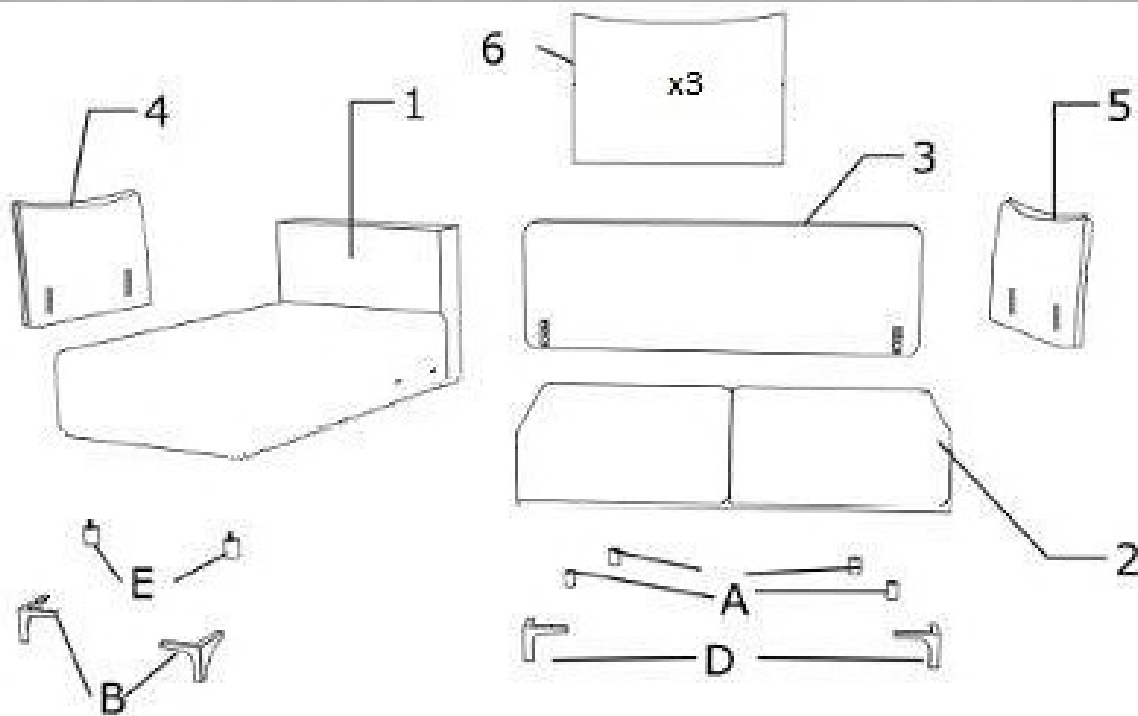

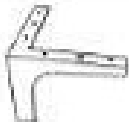
x1

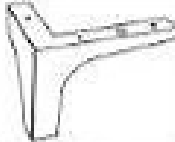

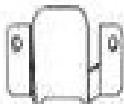
x2



<b>A</b>	x4	<b>B</b>	x2	<b>C</b>	x18	<b>D</b>	x2	<b>E</b>	x2
									
<b>F</b>	x8	<b>G</b>	x4	<b>H</b>	x4	<b>I</b>	x12	<b>J</b>	x4
					M6 x 25mm		M6 x 20mm		





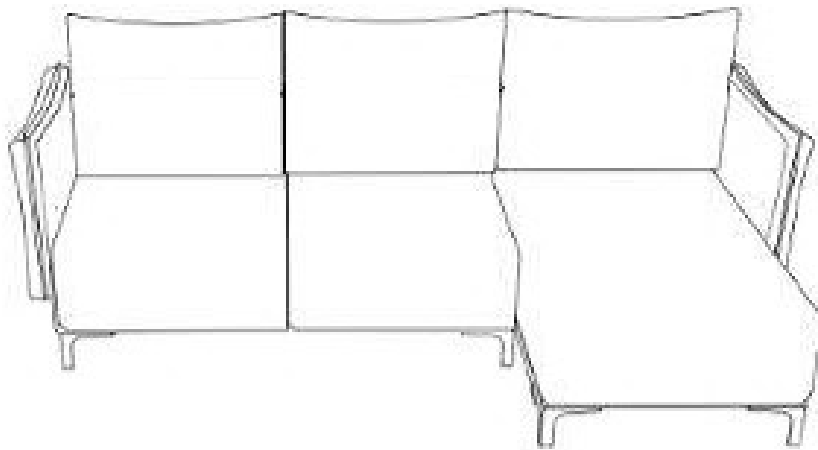
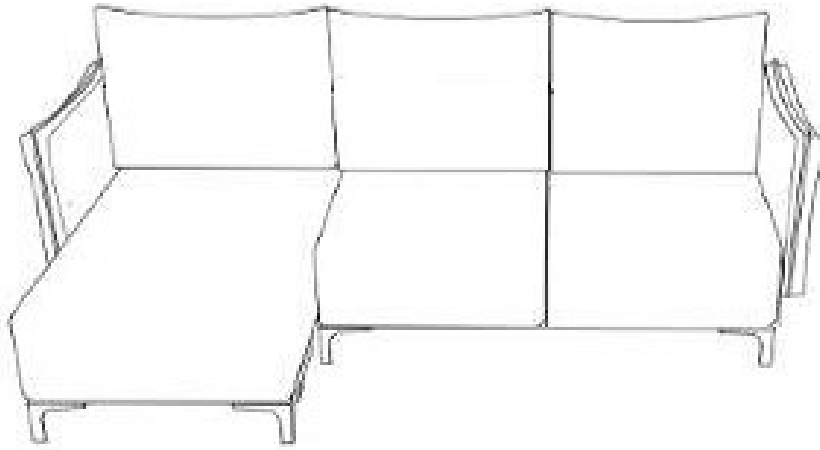

**1**

**L**







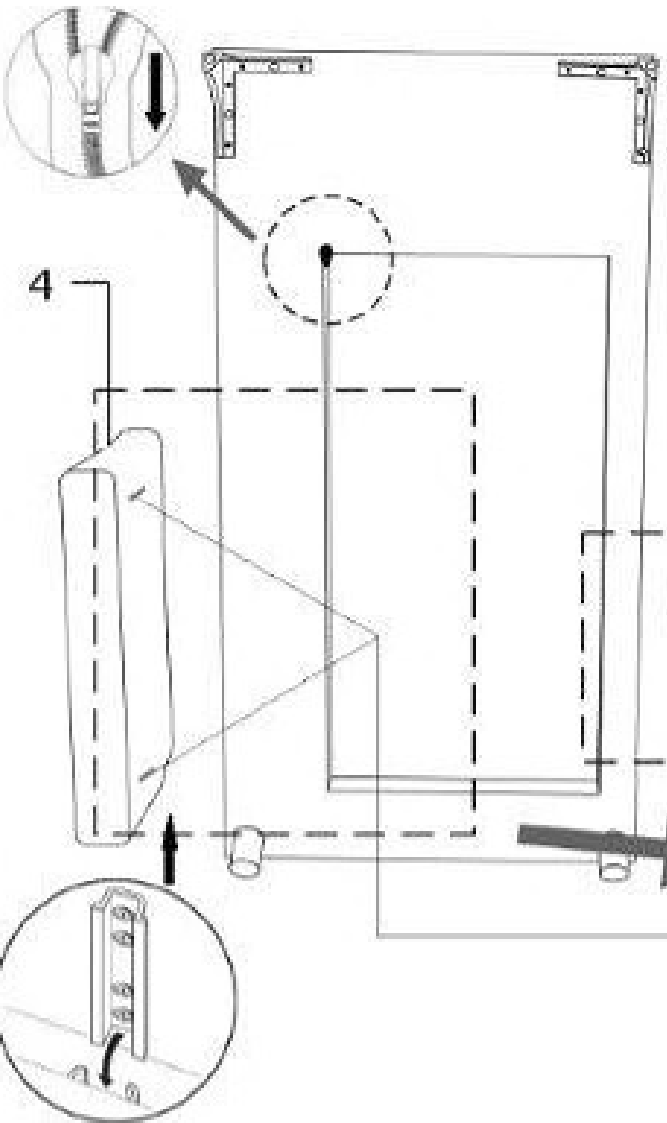
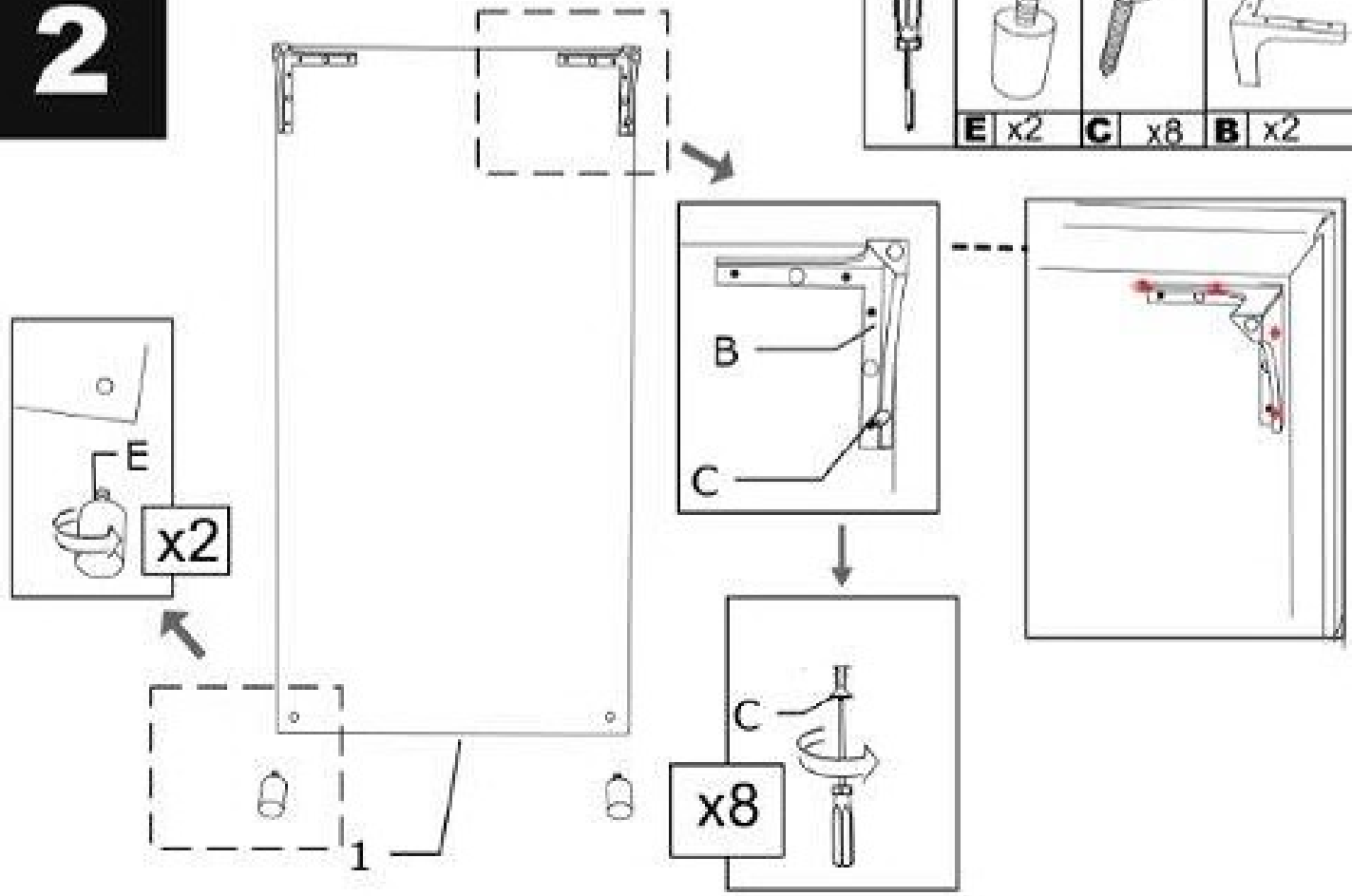

**R**

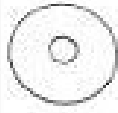
# 2

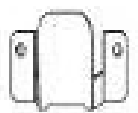

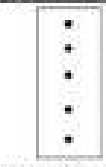

			
	<b>E x2</b>	<b>C x8</b>	<b>B x2</b>

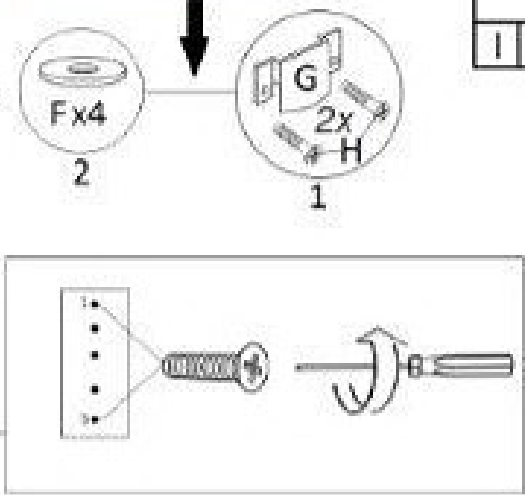



<b>L/R</b>			
	<b>F x4</b>	<b>H x4</b>	<b>G x2</b>
			<b>J x2</b>
			<b>I x4</b>



# 3

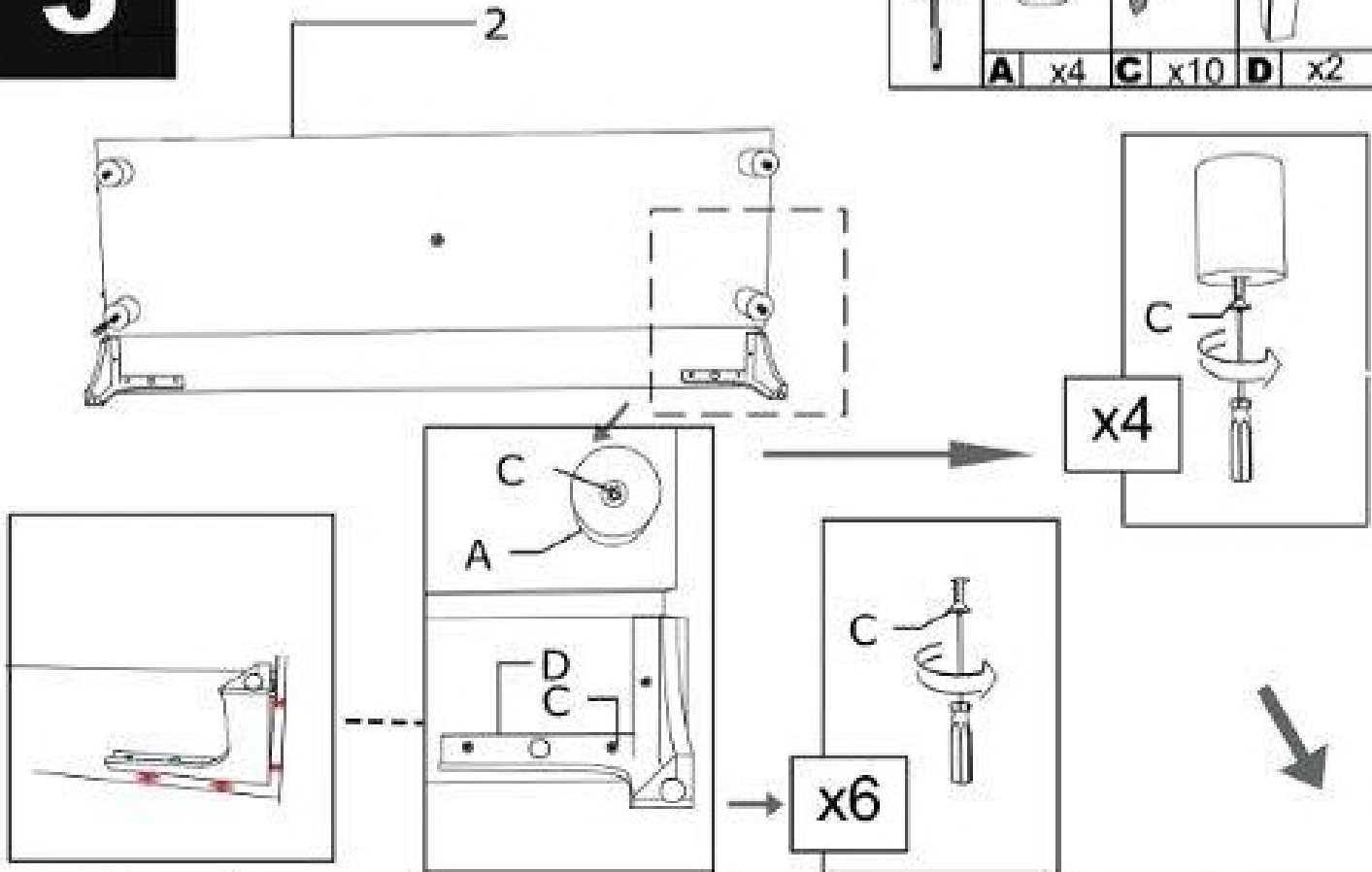

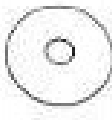
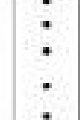
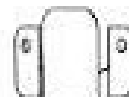
			
<b>A</b>	x4	<b>C</b>	x10
		<b>D</b>	x2

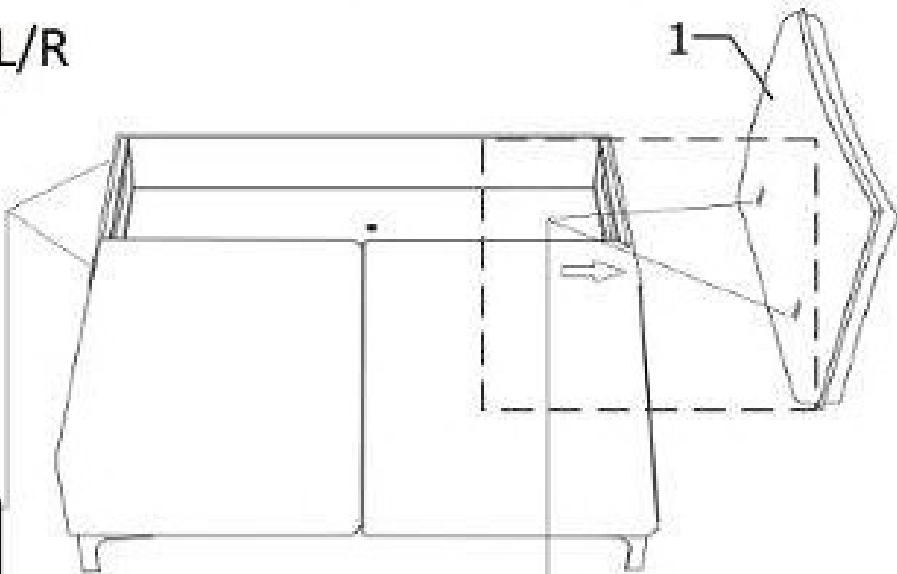

			
<b>F</b>	x4	<b>J</b>	x2
		<b>G</b>	x2
			
	<b>I</b>	x8	

L/R

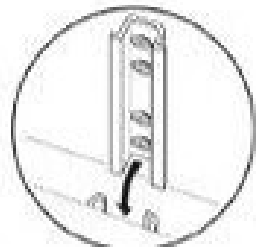
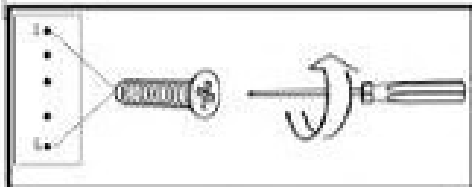

	
<b>F</b>	x4
2	1
	<b>G</b>
	2x
	<b>H</b>

4

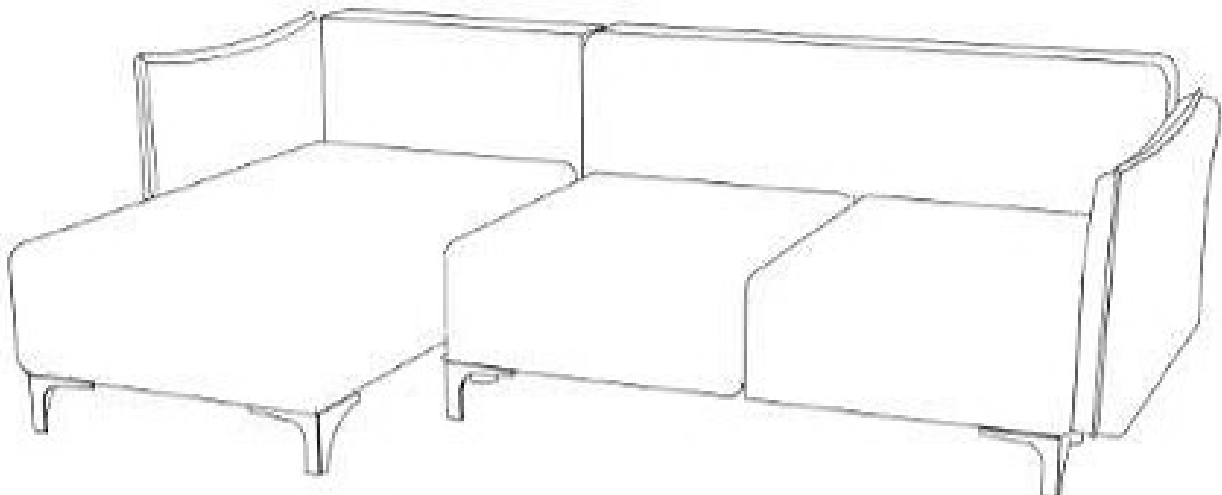
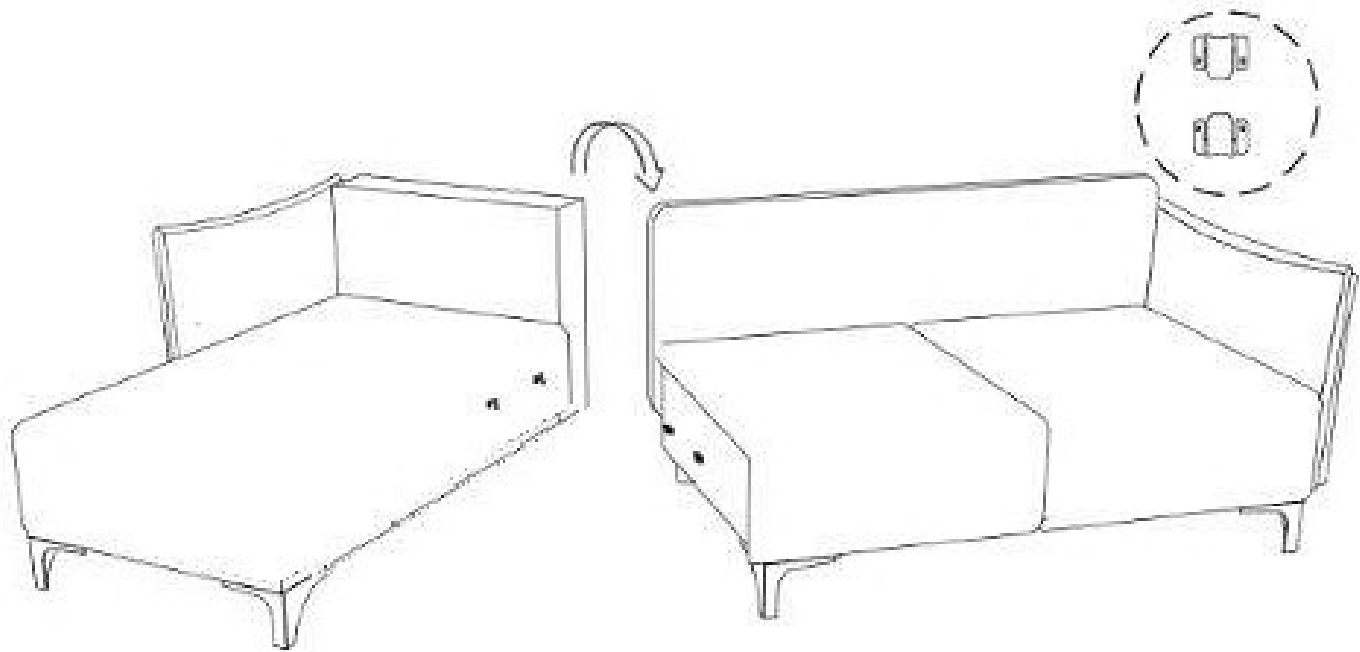
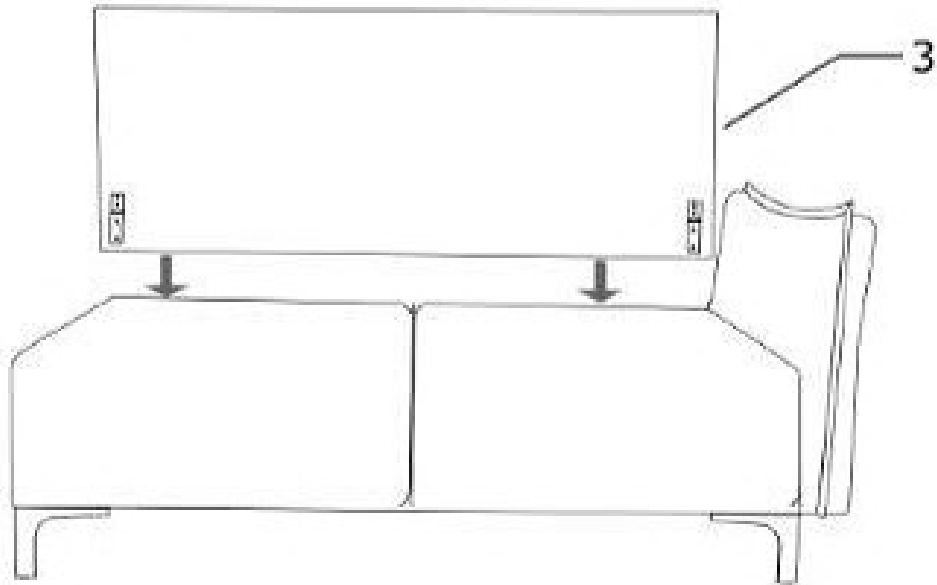

5

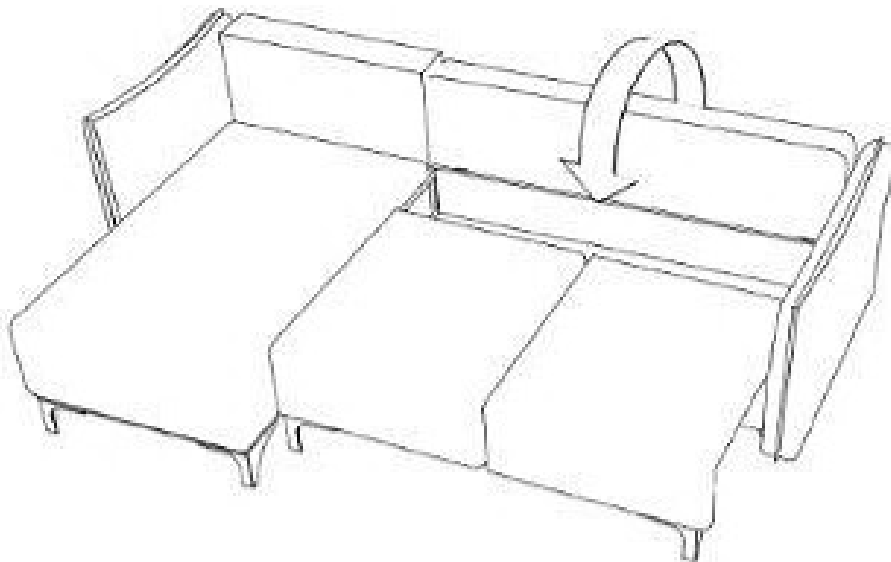
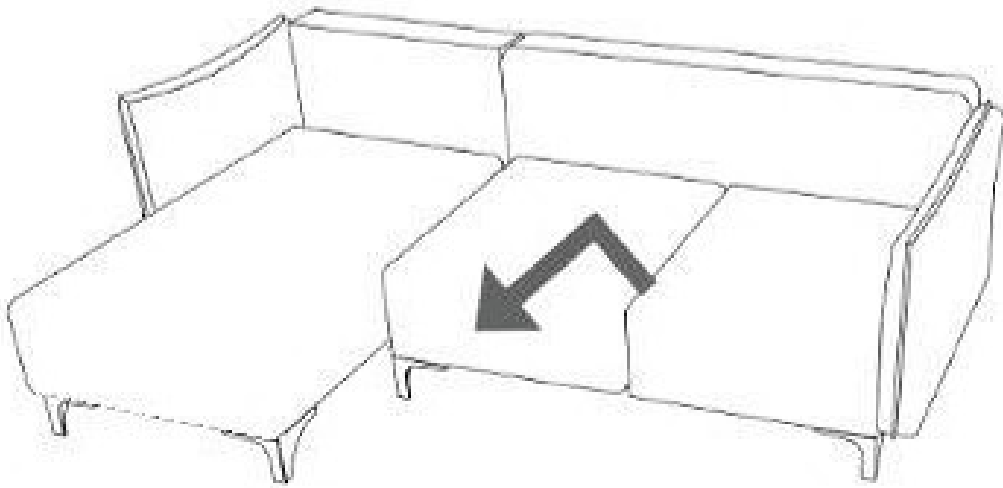

6

