

WICHTIG!!!

Damit der Schrank nicht kippen kann, muss er mit dem beigelegten Kippschutz an der Wand gesichert werden!

Achtung! Die dem Kippschutz beigelegten Schrauben sind ausschließlich für die Befestigung des Kippschutzes am Möbelstück vorgesehen. Für die Befestigung des Kippschutzes an der Wand benötigen Sie zusätzlich Schrauben oder Beschläge, die zur Beschaffenheit der Wand passen. Falls Sie nicht sicher sind, welche Art von Schrauben geeignet sind, wenden Sie sich bitte an den Fachhandel.

Nicht in Installations-Leitungen bohren!

Important!!!

Afin d'éviter que l'armoire pourrait basculer, il est impératif de fixer l'armoire au mur avec le set de fixation livré avec.

Attention! La vis fournie avec la dispositif anti-bascule est destinée à fixer le dispositif dans le meuble. Pour la fixation au mur, compléter par une vis adaptée au support mural. En cas de doute, contacter un magasin de bricolage.

Ne pas forer dans les systèmes d'installations!

Importante!!!

Per evitare che l'armadio si ribalti, bisogna fissarlo al muro con le apposite staffe di sicurezza in dotazione.

Attenzione! Le viti che sono allegate nel pacchetto con la staffa di sicurezza antiribaltamento, sono esclusivamente per il fissaggio della staffa antiribaltamento all'armadio. Per il fissaggio del antiribaltamento sul muro sono necessari ulteriori viti o accessori che corrispondono alla consistenza del muro. Se non siete sicuri, quale tipo di viti o accessori usare, si prega di informarsi presso un negozio di ferramenta.

Non perforare nelle tubazioni d'installazione

Important!!!

To prevent the cabinet to tilt, it has to be secured to the wall with the enclosed wall straps / clips!

Attention! The screw supplied together with the anti-topple bracket is to be used only for fixing the anti-topple bracket to the furniture. In addition to this, you will need to choose a screw or fitting which is suitable for securing the bracket to the kind of walls you have. If you are unsure about what type of screw to use, please contact your local hardware store.

Do not bore whether into feeders nor into service pipes!

Belangrijk!!!

Om te zorgen dat de kast niet kan omvallen, moet de kast met de bijgeleverde set aan de wand vastgezet worden.

Attentie! De schroeven die bij de wandbevestiging zitten, zijn uitsluitend bedoeld om de wandbevestiging aan het meubel te bevestigen. Completeer de wandbevestiging met een schroef of bevestigingsbeslag dat geschikt is voor het materiaal van de wand. Neem bij twijfel contact op met de ijzerhandel.

niet in elektriciteits leidingen boren.

Importante!!!

Para evitar el basculamiento del armario, ancla como prevencion la fijacion a la pared.

Atención! El tornillo que viene incluido con el soporte antivuelco está destinado a fijarlo en el mueble debes fijar el antivuelco en la pared con un tornillo o similar de un tipo acorde con el material de ésta. Consulta con tu ferretería.

No perforar los cables de installation

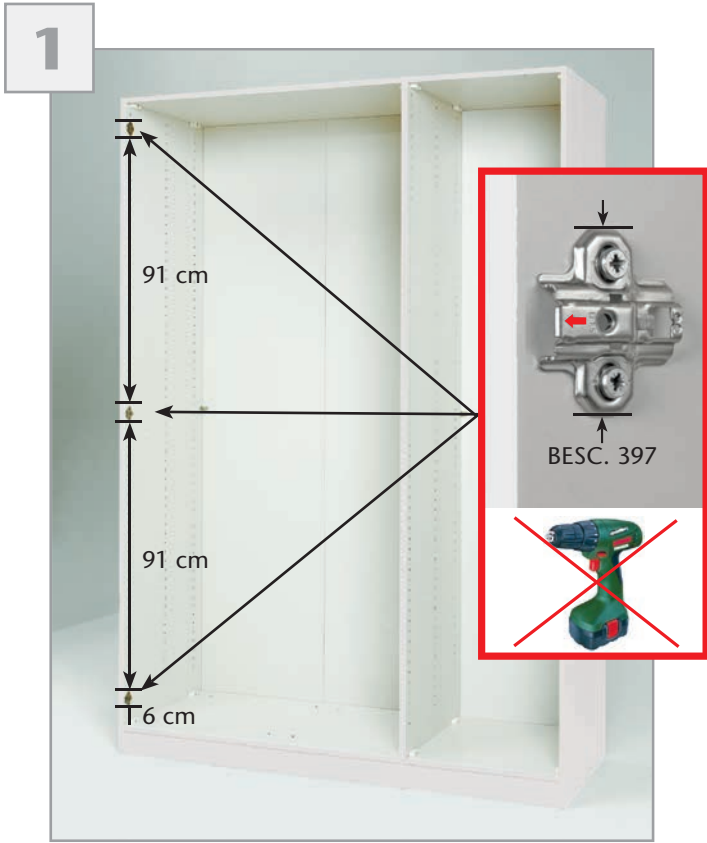

4

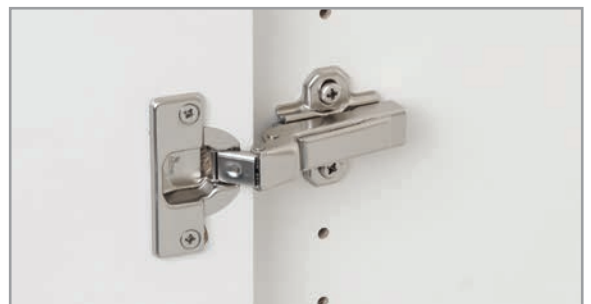
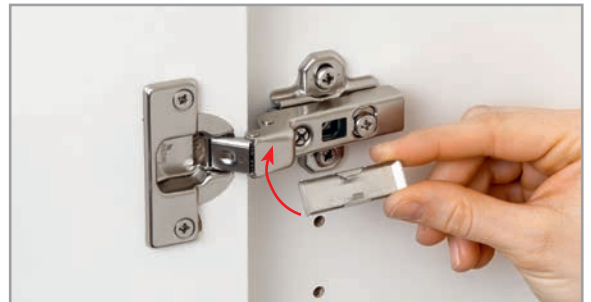
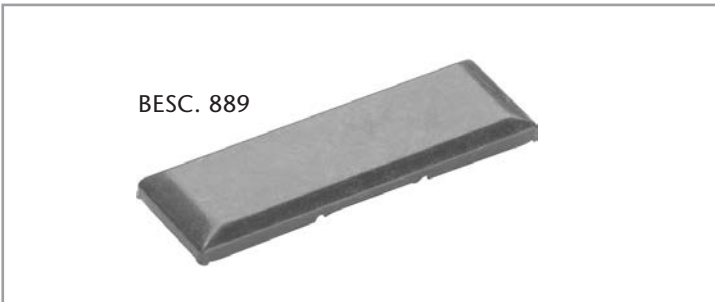
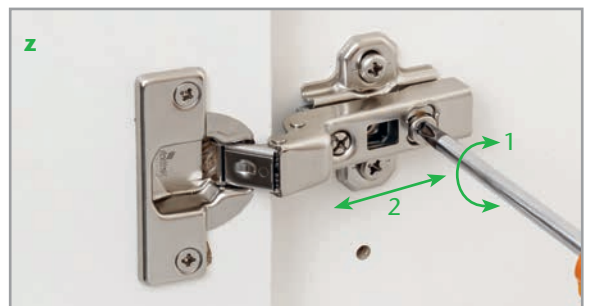
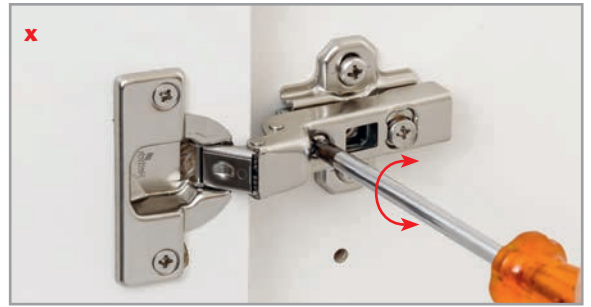
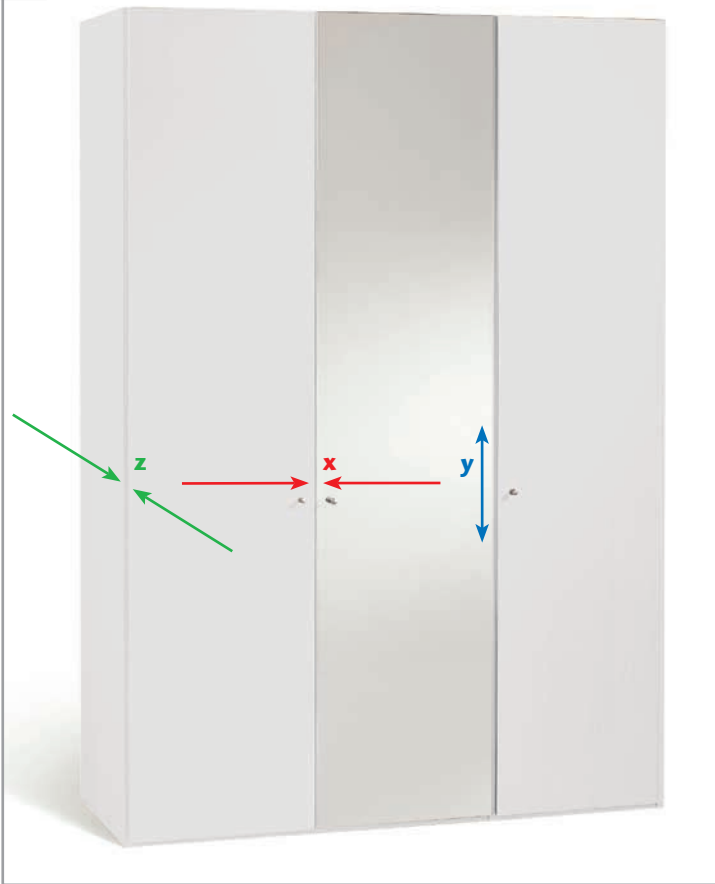

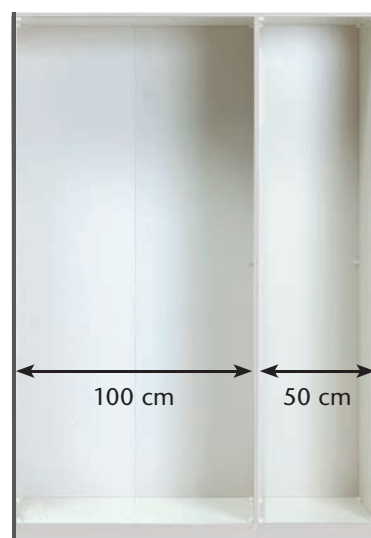
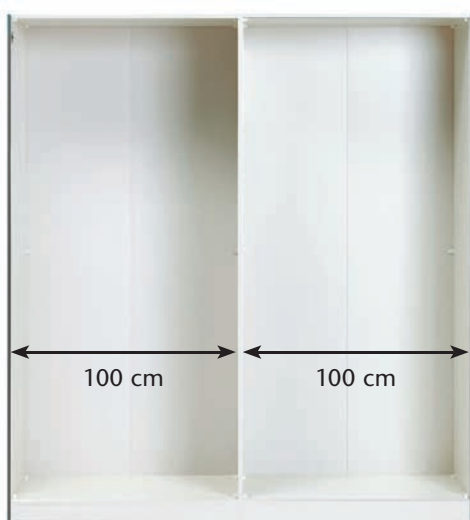

Mod. .../80 TLL+.../82 TLL

PACK. 487



4 x
SCHR. 322
M4 x 8 mm



4 x
SCHR. 310
M4 x 16 mm



8 x
SCHR. 342
3,5 x 15 mm



74 x
SCHR. 325
6,3 x 10,5 mm



4 x
BESSC. 423
8 mm



2 x Q

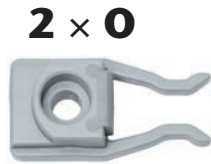

2 x O

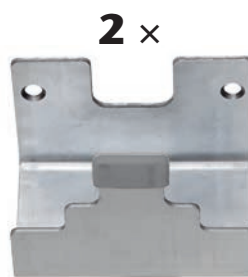

2 x

12442



2 x

1226
BESSC. 580/8

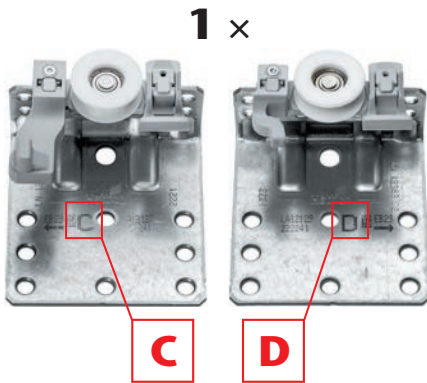

1 x

C

D

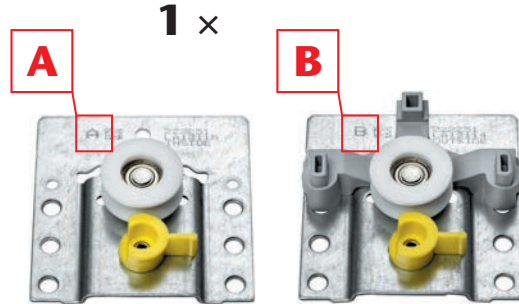

1 x

A

B



2 x P

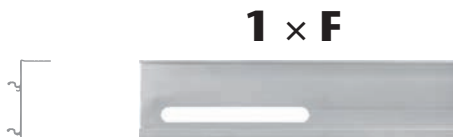

1 x F



1 x G



3 x I



1 x J

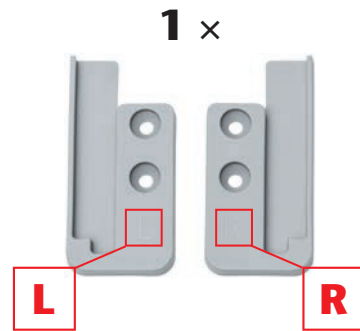

1 x

L

R



4 x M



3 x H

M: 1:1

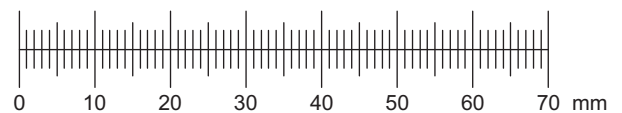

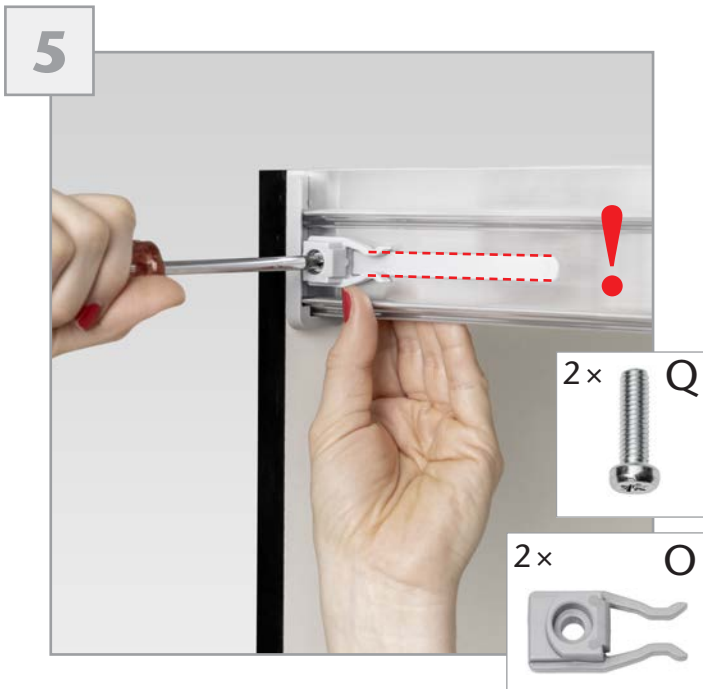
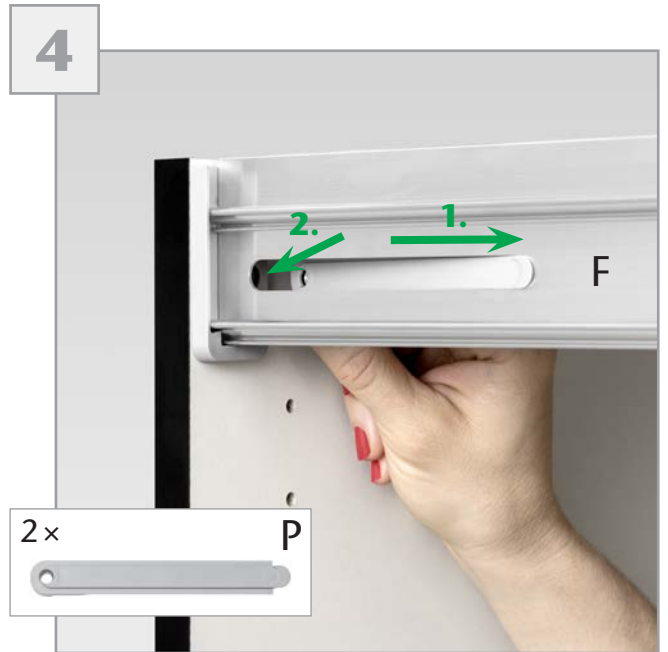
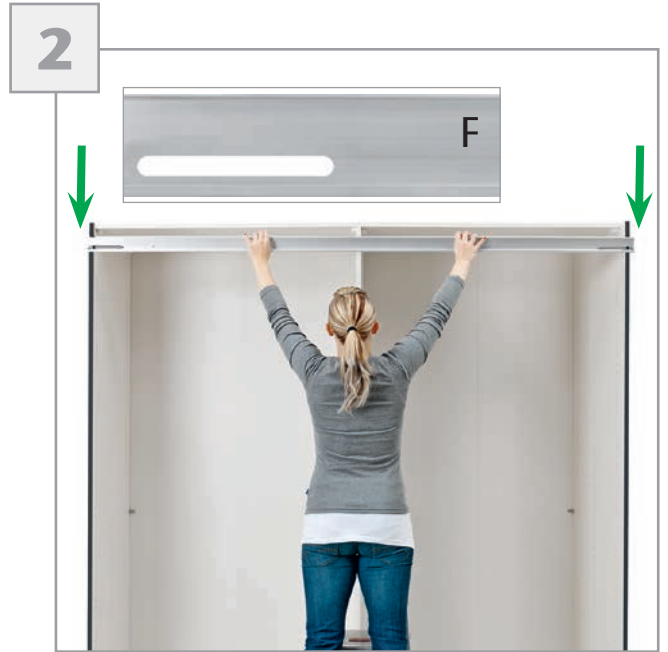

7



8



9



10

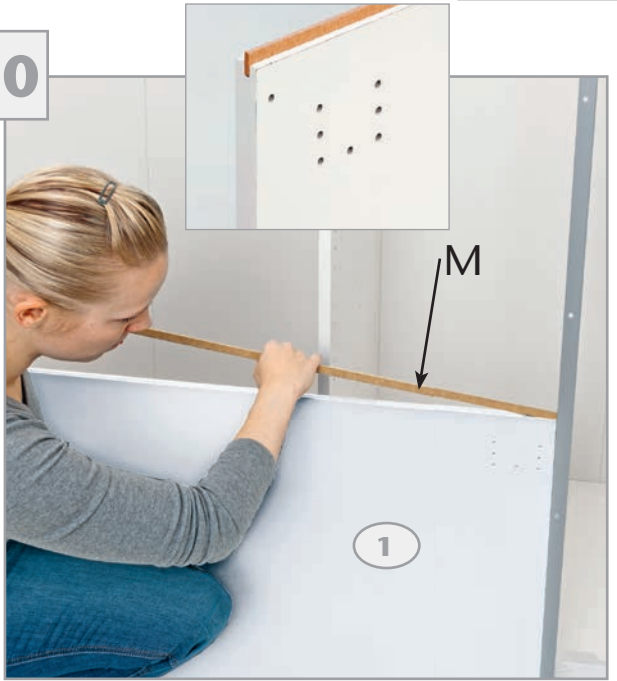

11



12



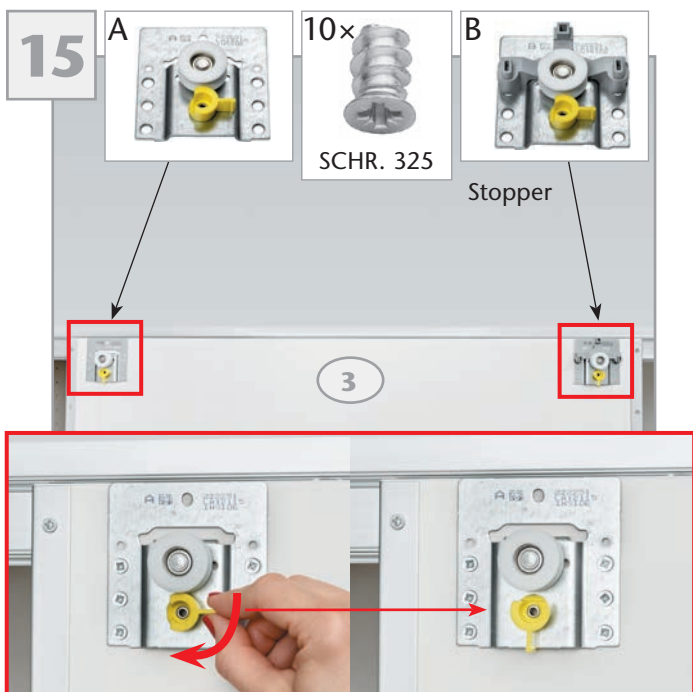
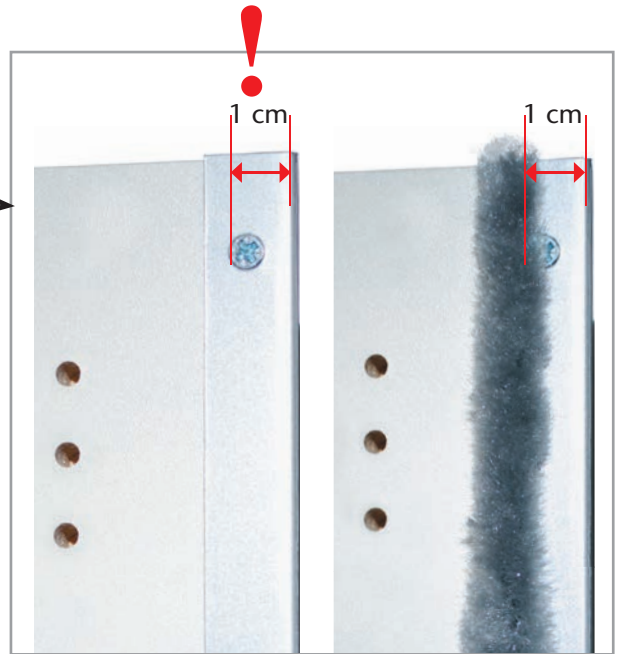
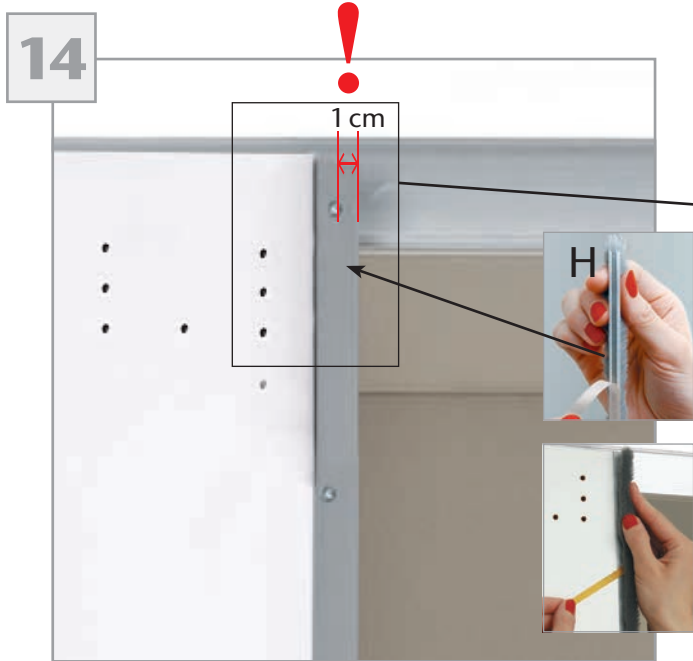
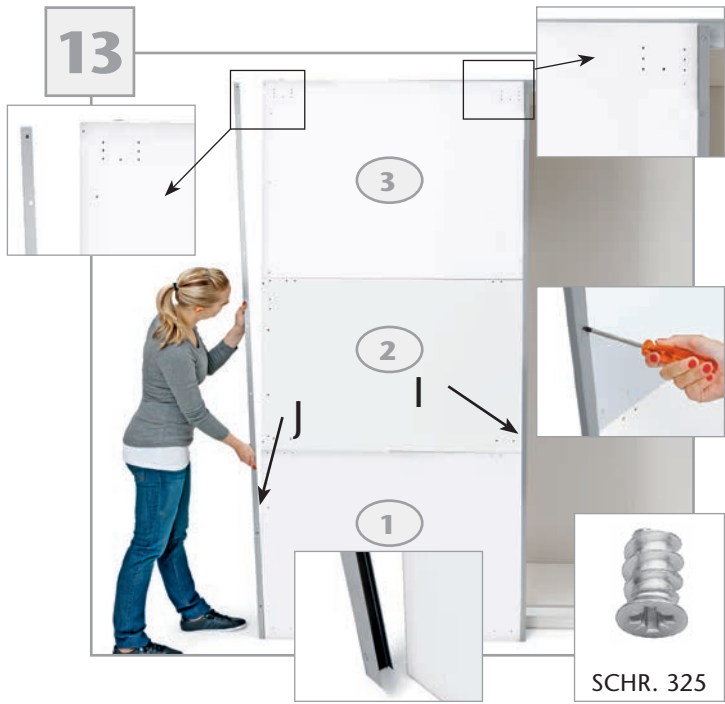

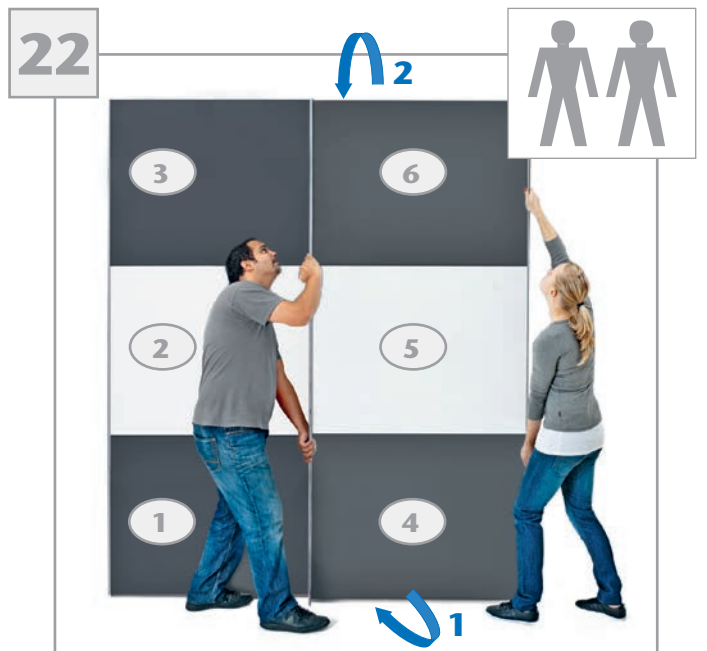
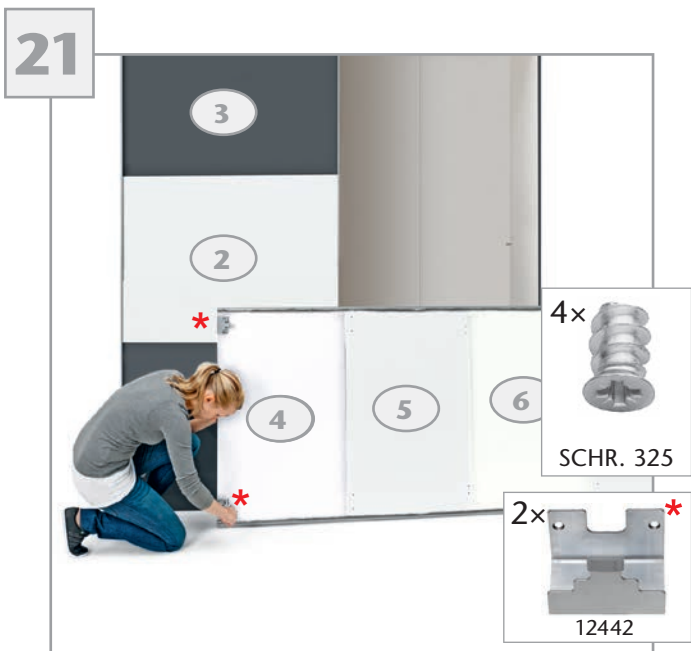
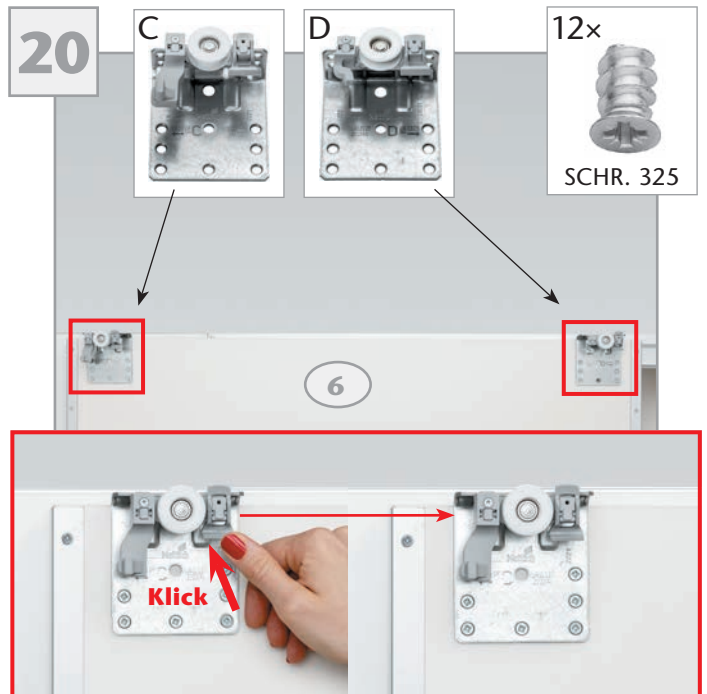
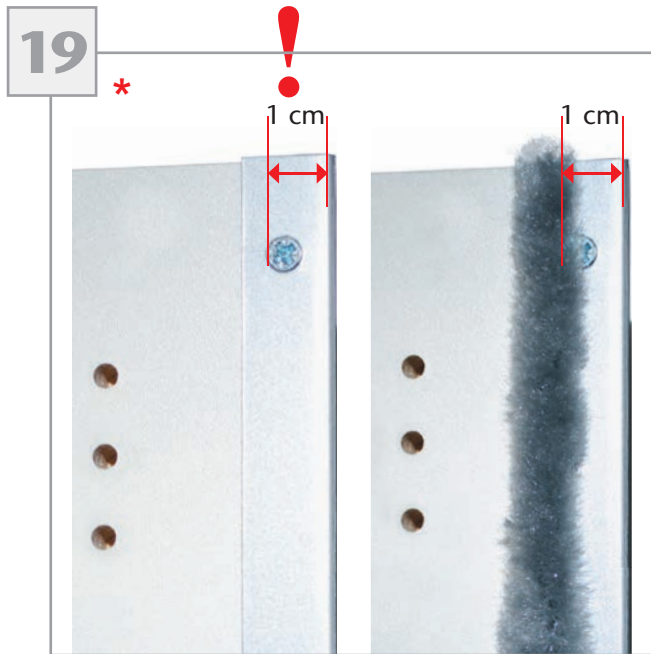
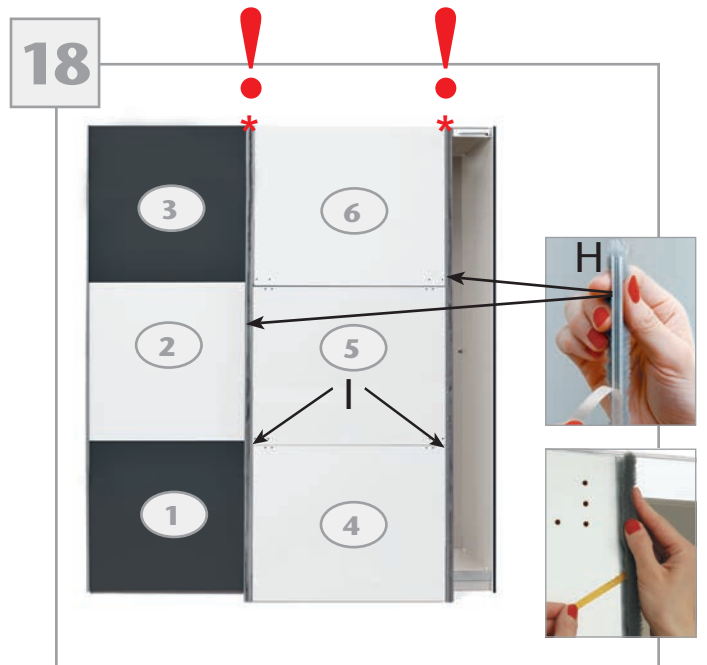

23



24



