

<b>A</b>  1x	<b>B</b>  1x	<b>C</b>  7x H-100	<b>D</b>  4x H-100	<b>E</b>  16x 3,5x25	<b>F</b>  1x
--------------------	--------------------	-----------------------------	-----------------------------	-------------------------------	--------------------

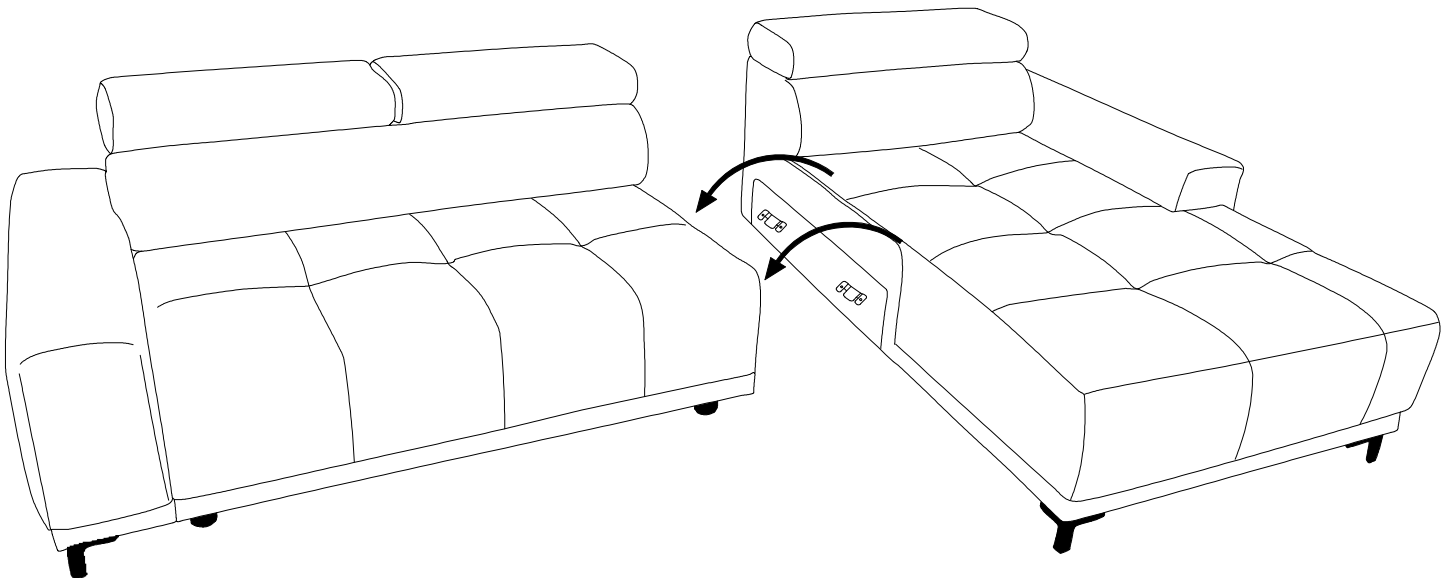

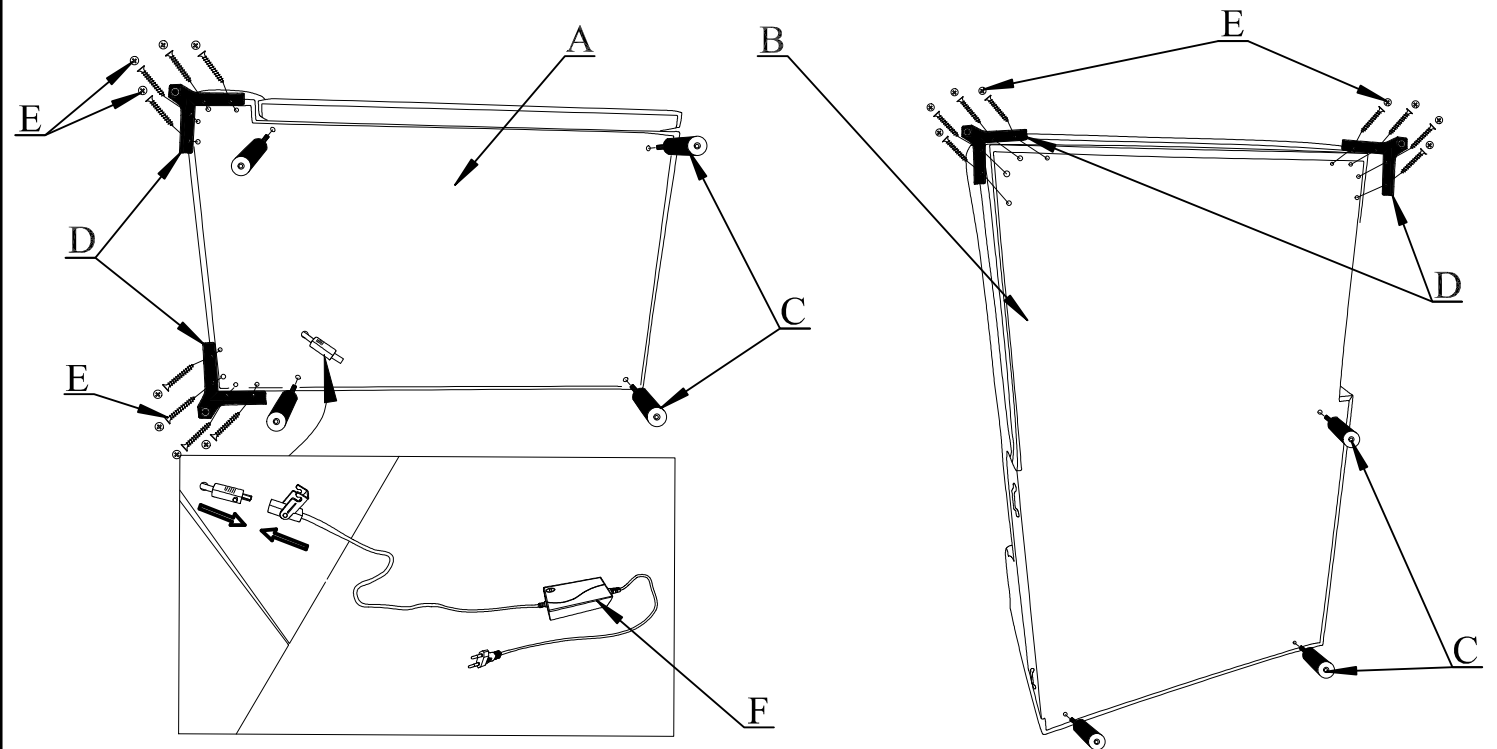

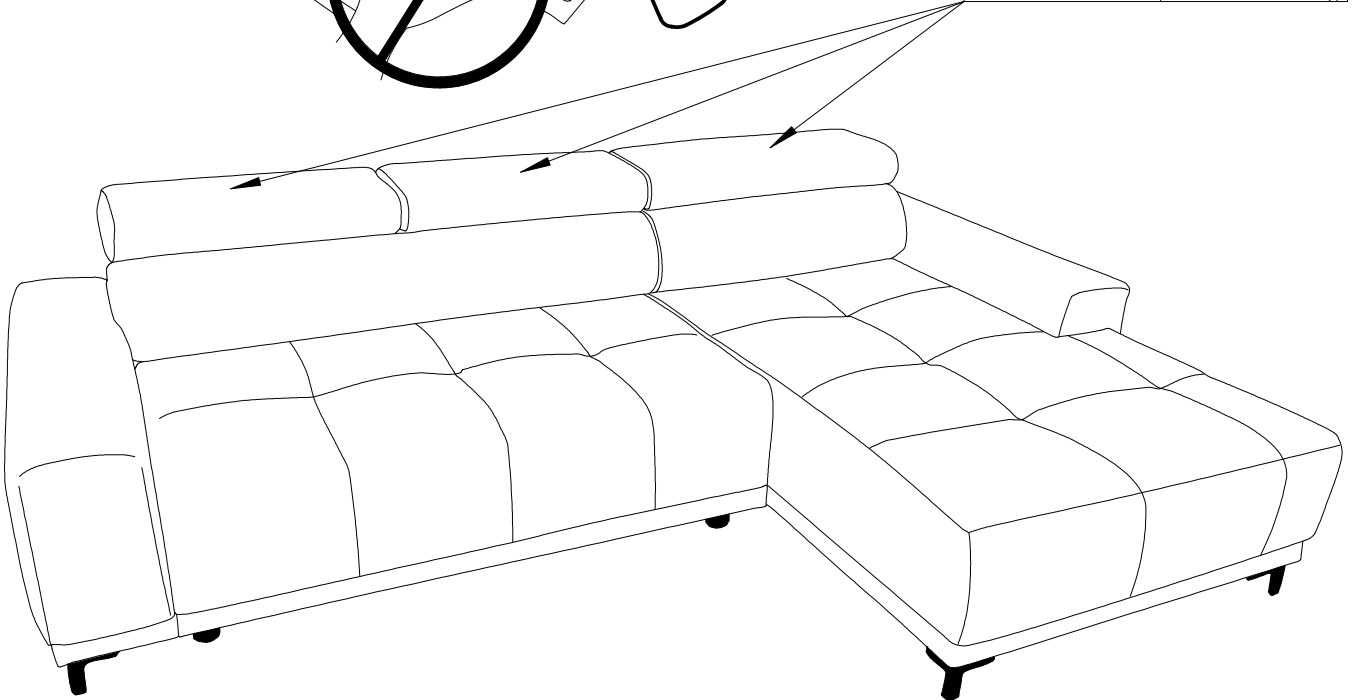

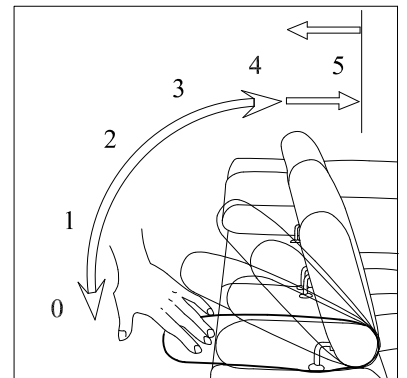
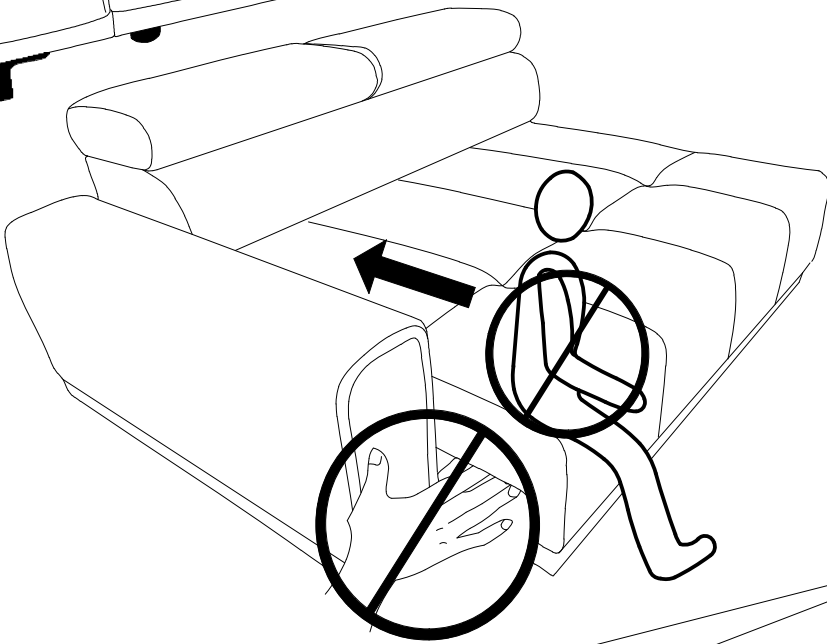
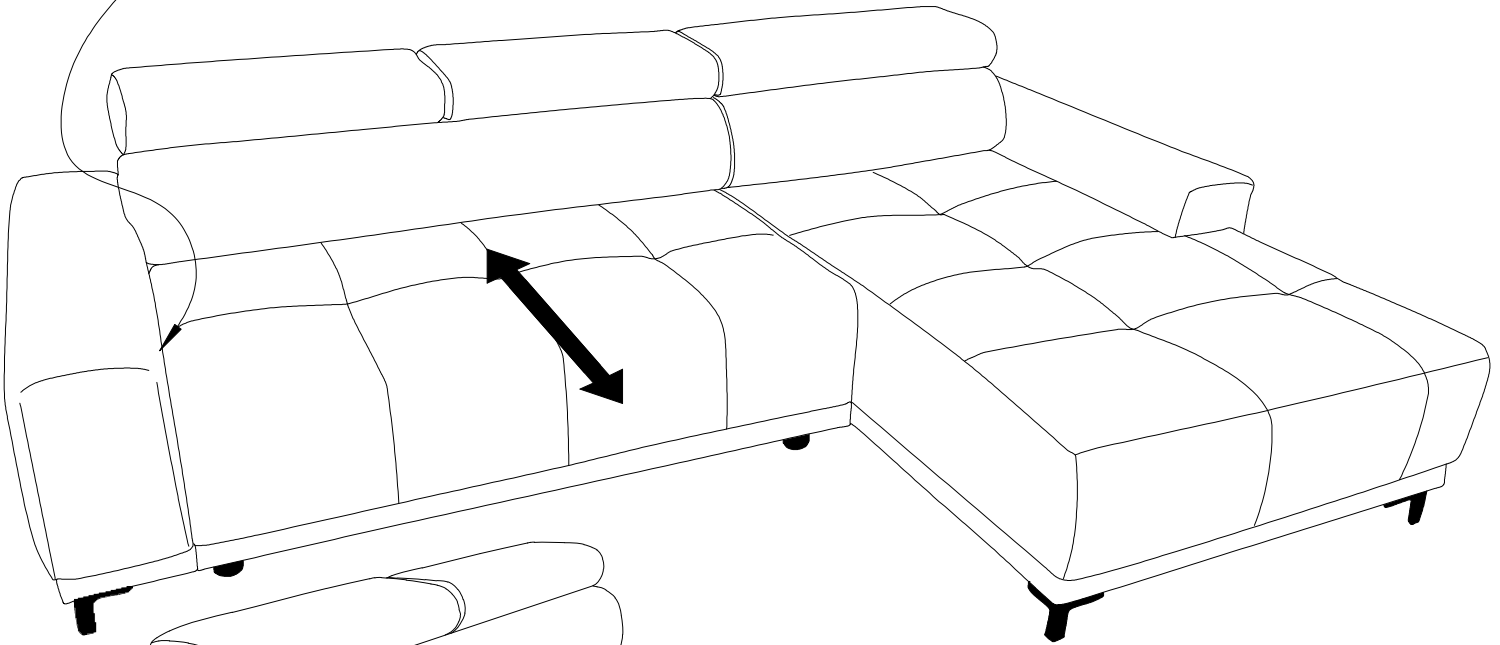
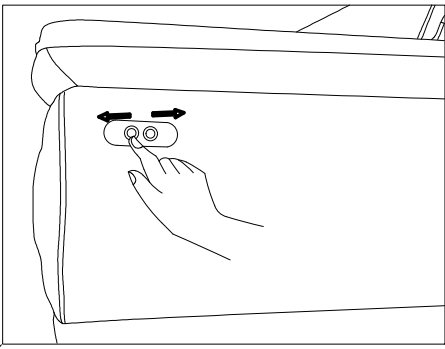
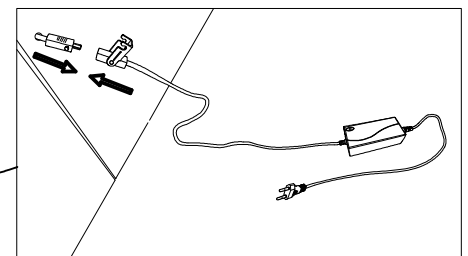
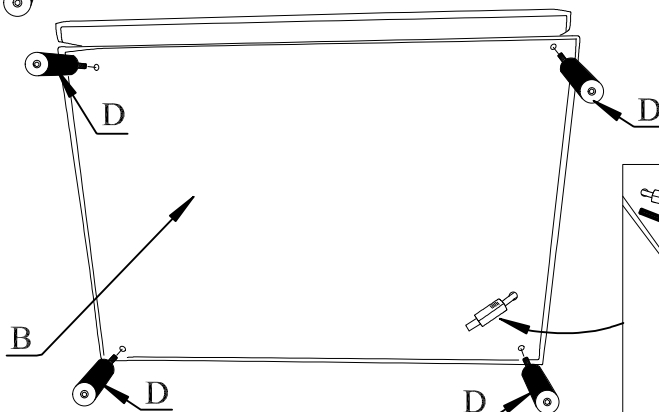
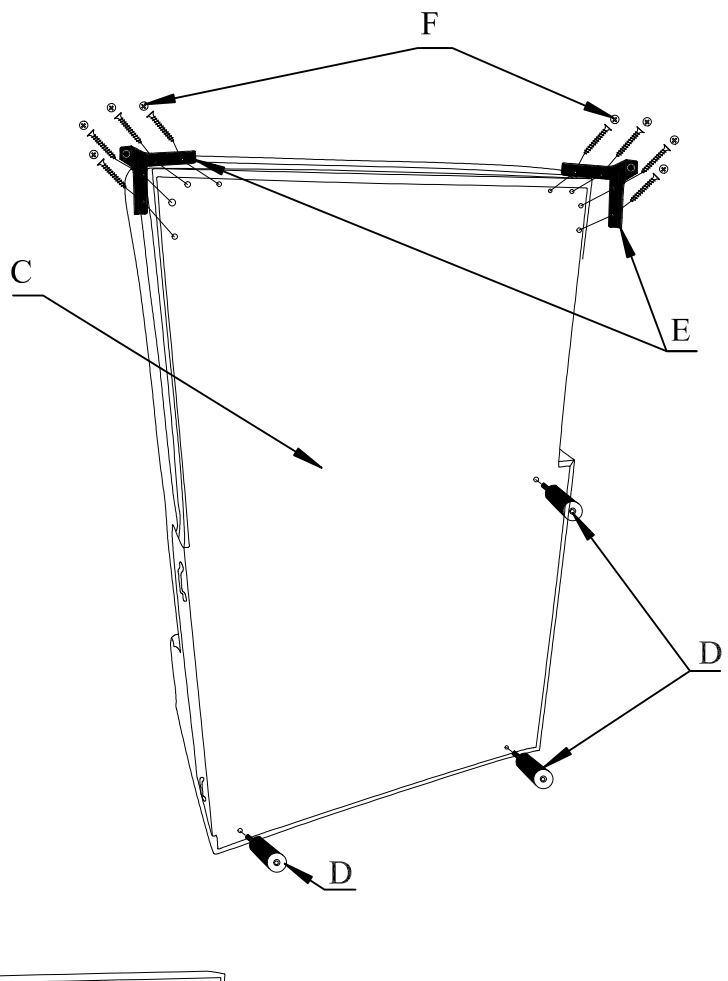
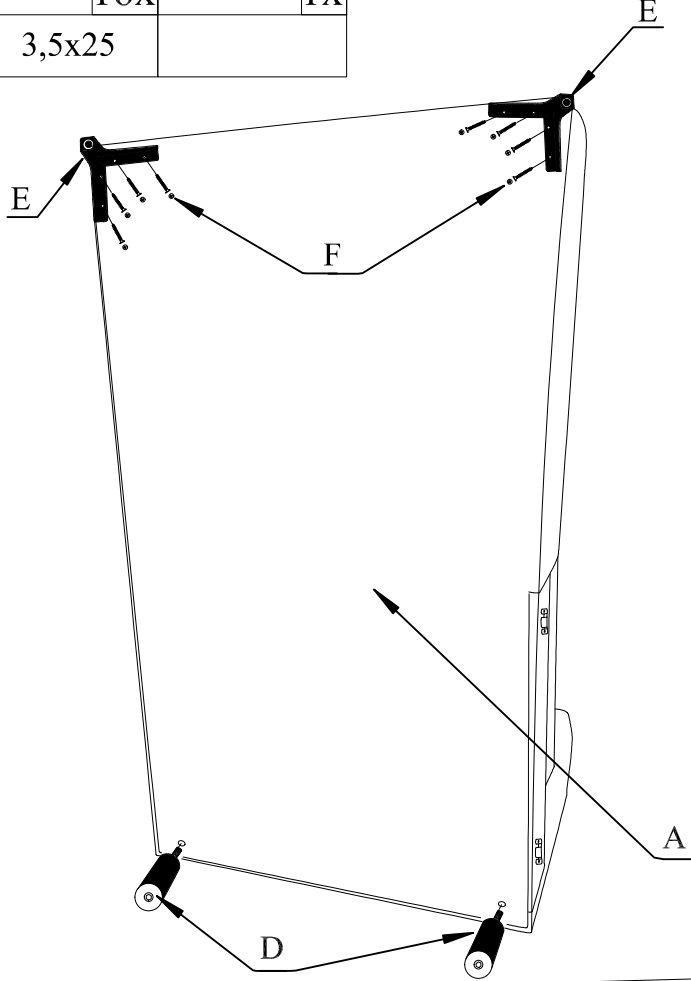
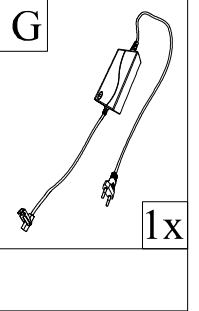
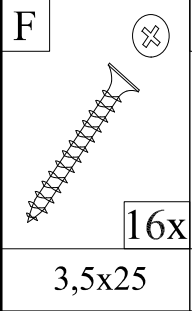
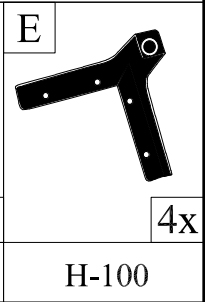
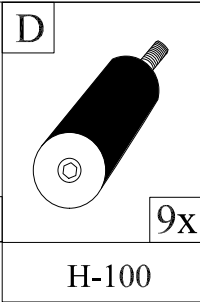
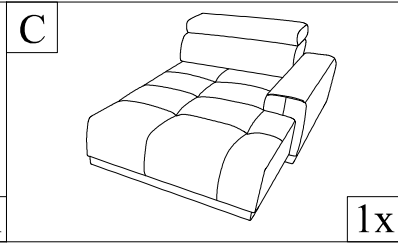
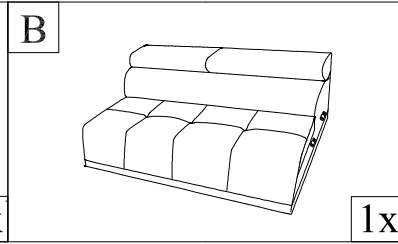
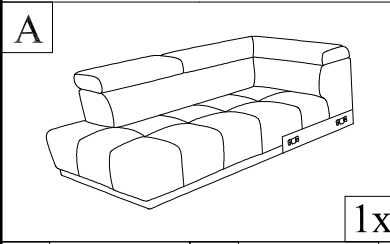
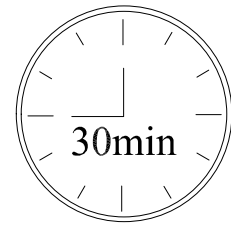
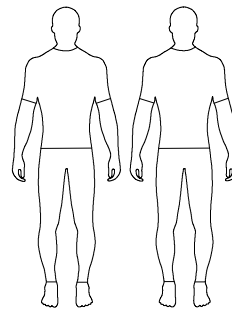
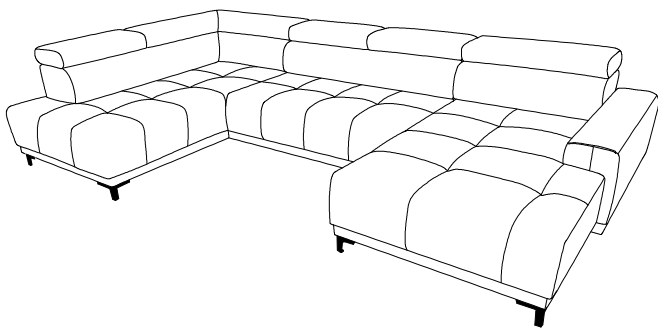
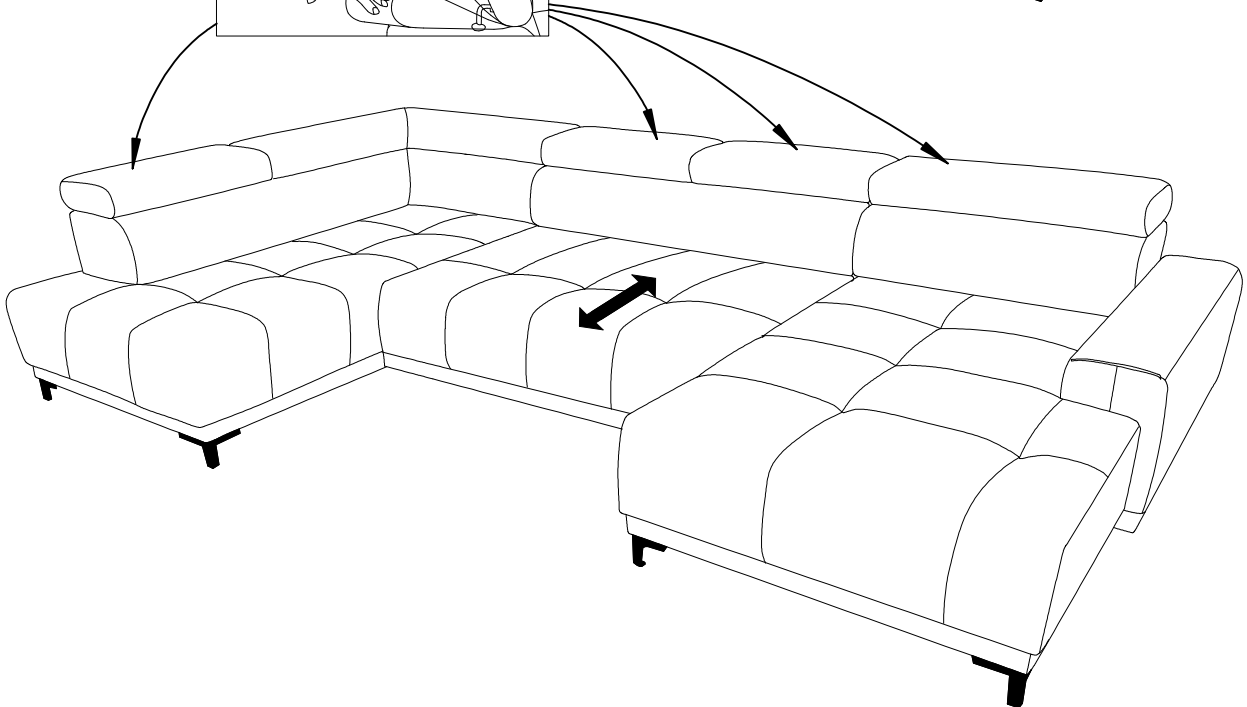
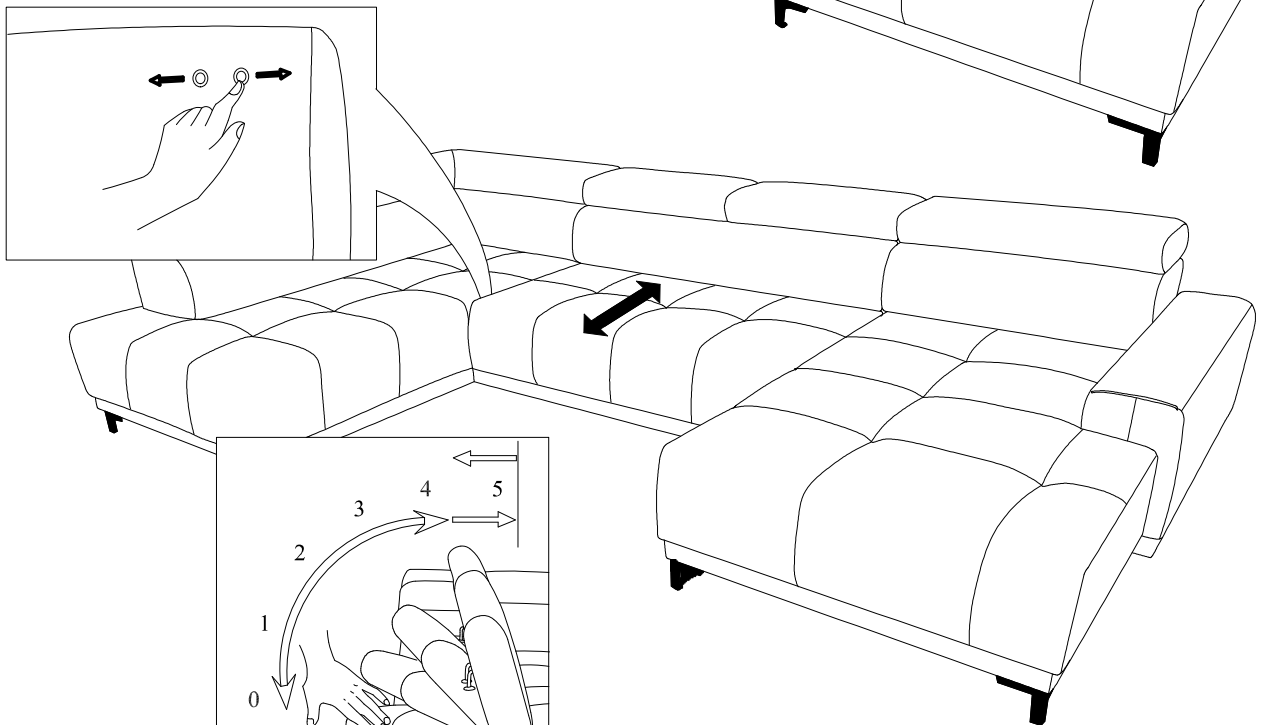
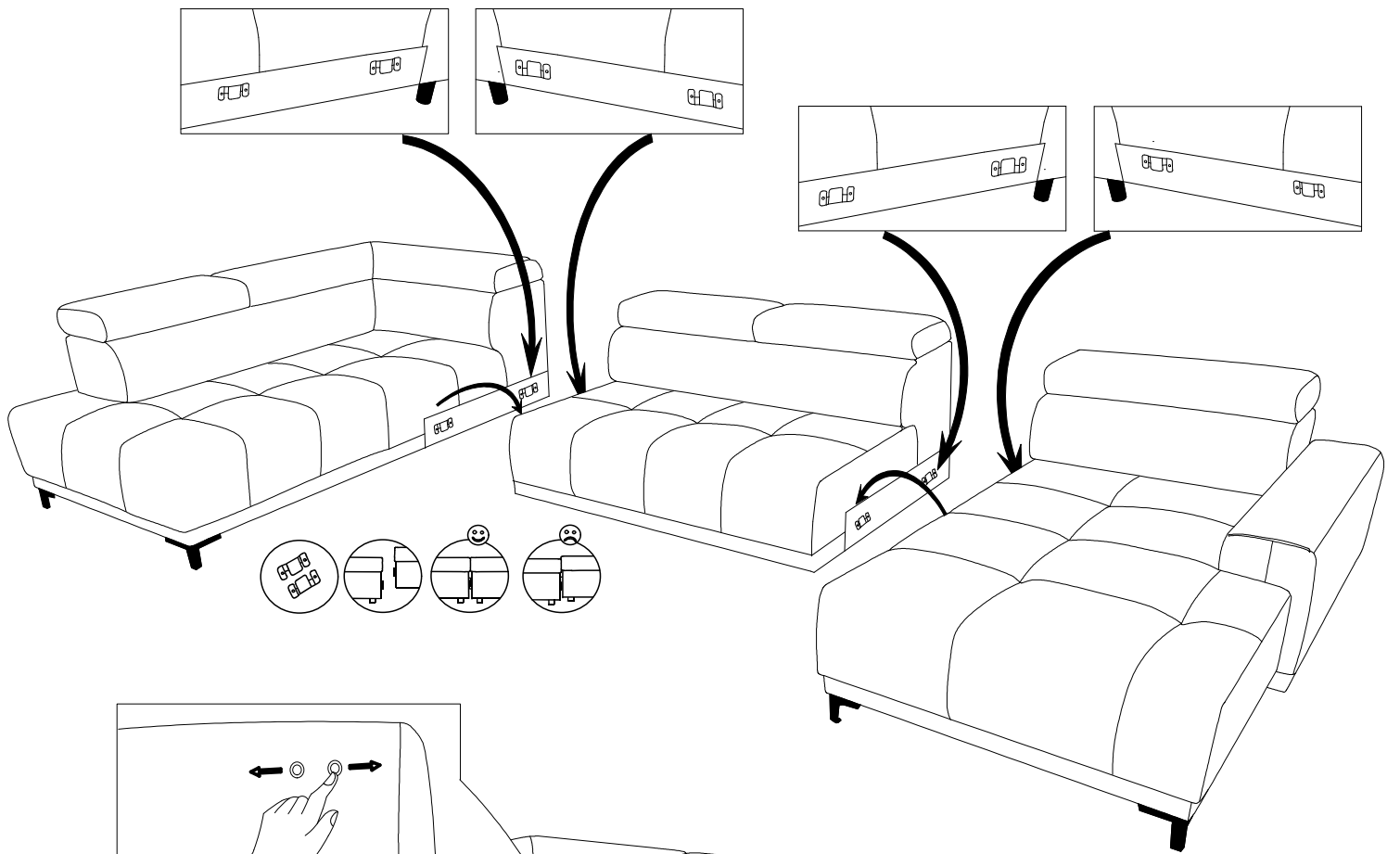

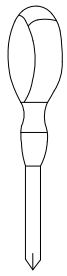
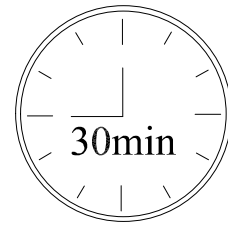
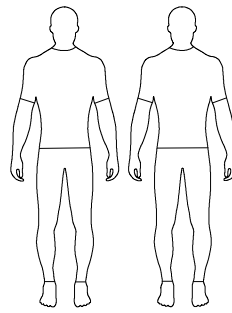
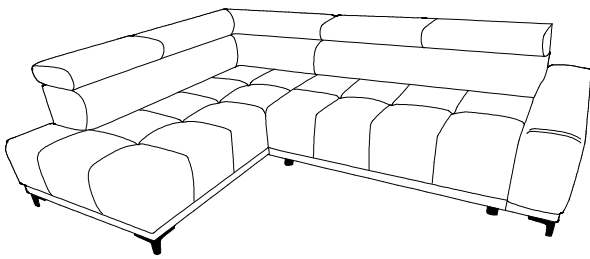

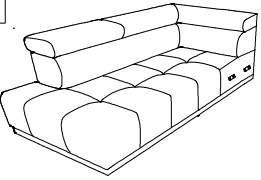
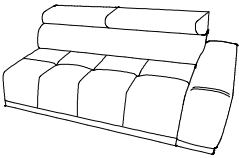
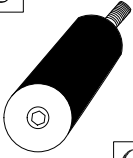

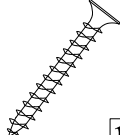
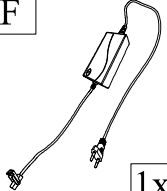
 <p>1x</p>	 <p>1x</p>	 <p>6x</p> <p>H-100</p>	 <p>4x</p> <p>H-100</p>	 <p>16x</p> <p>3,5x25</p>	 <p>1x</p>
--	---	--	---	--	---

